

# FEFCO CODE

© 2022

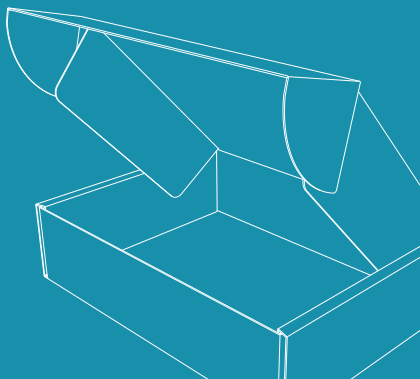
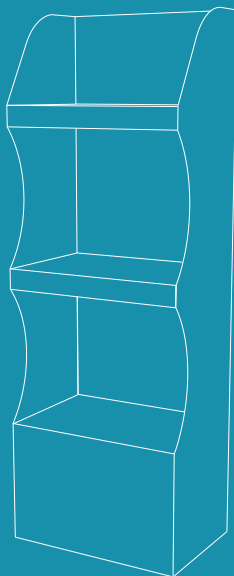
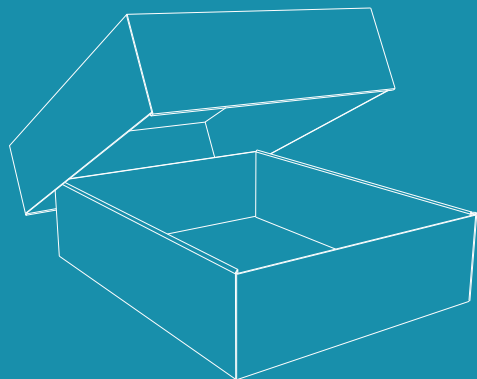

DESIGN STYLE LIBRARY  
FOR CORRUGATED BOARD PRODUCTS

**FEFCO**  
Corrugated Packaging

The FEFCO code is the internationally recognised system for the classification of corrugated board packaging designs. It contains designs of the most common box types with a code number attached to each design, simplifying the identification process.

## **PUBLISHED BY FEFCO**

Avenue Louise 250  
1050 – Brussels  
Belgium  
[www.fefco.org](http://www.fefco.org)

Adopted by ICCA,  
the International Corrugated Case Association,  
with its worldwide membership.  
[www.iccanet.org](http://www.iccanet.org)

# CONTENT

<b>0100</b> Commercial rolls and sheets	5
<b>0200</b> Slotted boxes	7
<b>0300</b> Telescopic boxes	11
<b>0400</b> Folder boxes and trays	15
<b>0500</b> Slide boxes	25
<b>0600</b> Rigid boxes	27
<b>0700</b> Ready-glued cases	29
<b>0800</b> Retail and e-commerce packaging	35
<b>0900</b> Interior fitments	41



0100

# COMMERCIAL ROLLS AND SHEETS

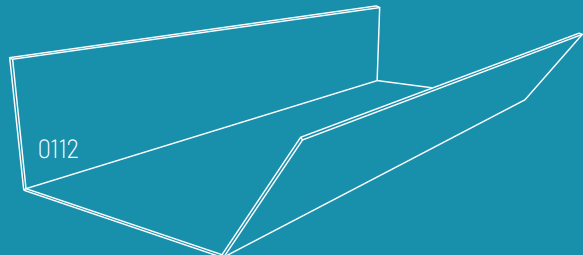
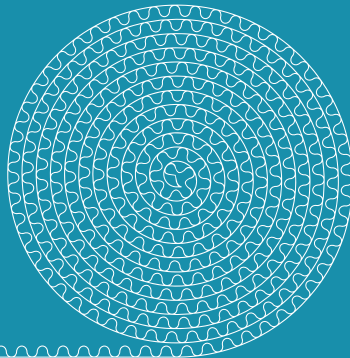
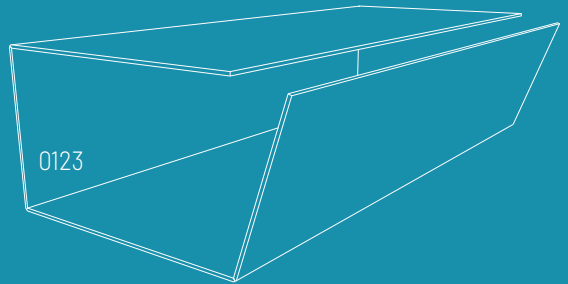

**0100**

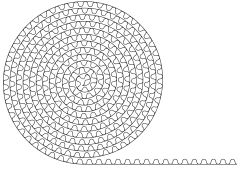

**0110**

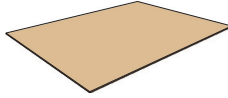

**0111**

**NEW**



**0112**

**NEW**

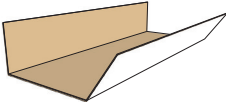

**0113**

**NEW**

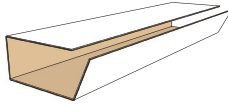

**0119**

**NEW**

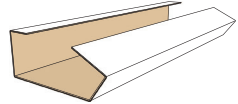

**0121**

**NEW**

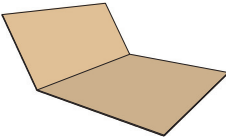

**0122**

**NEW**

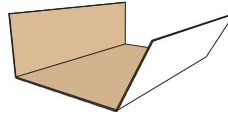

**0123**

**NEW**

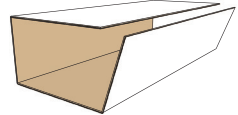

**0129**

**NEW**

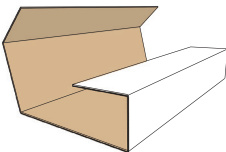

**0130**

**NEW**

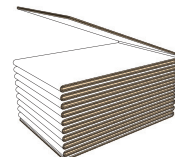

## SLOTTED BOXES

Slotted boxes consist of basically one piece with a glued, stitched or taped manufacturers joint and top and bottom flaps. They are shipped flat, ready to use and require closing using the flaps provided.

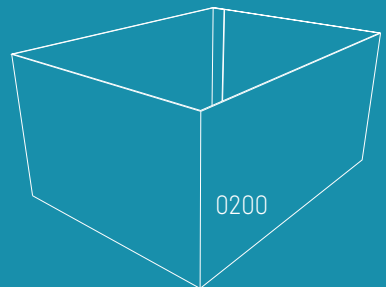
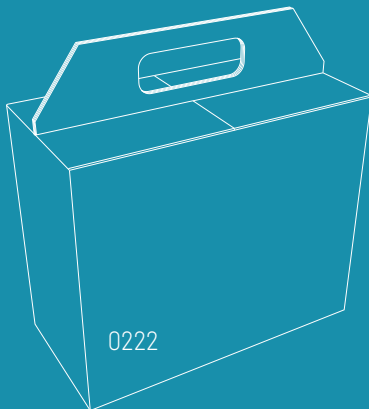
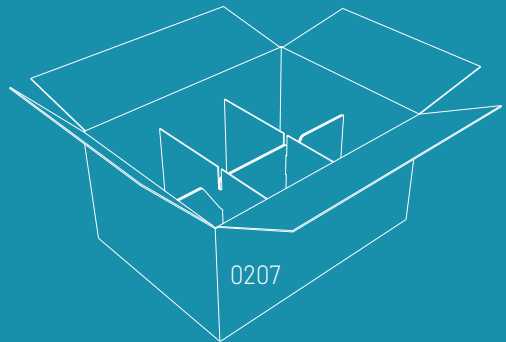
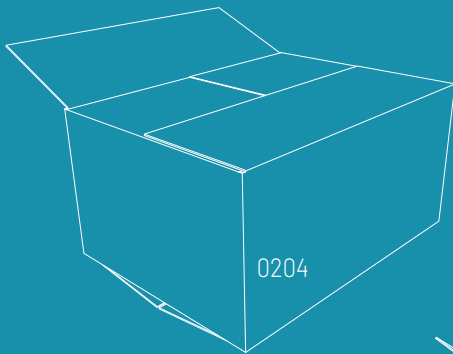

**0200** M/A

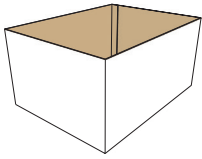

**0201** M/A

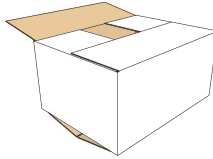

**0202** M/A

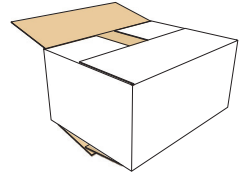

**0203** M/A

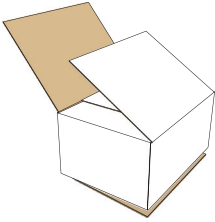

**0204** M/A

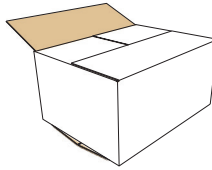

**0205** M/A

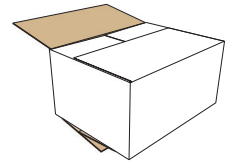

**0206** M/A

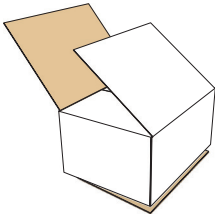

**0207** M

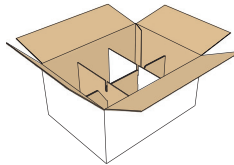

**0208** M

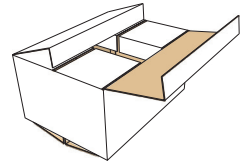

**0209** M/A

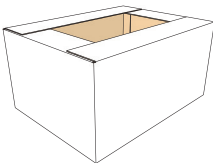

**0210** M

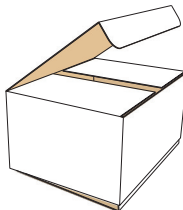

**0211** M

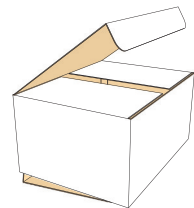



**0212** M/A

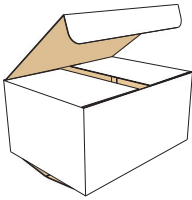

**0214** M

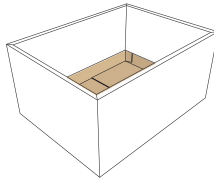

**0215** M

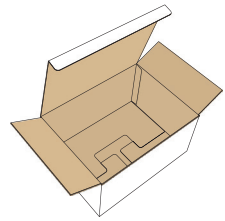

**0216** M

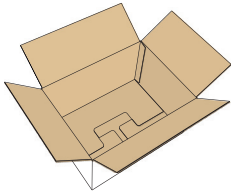

**0217** M

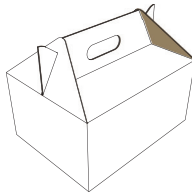

**0218** M

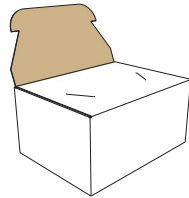

**0219** M

NEW

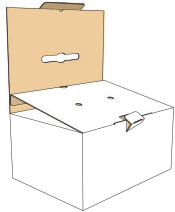

**0220** M

NEW

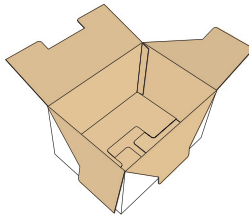

**0221** M

NEW

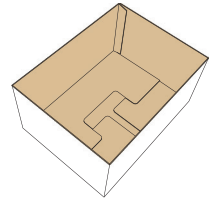

**0222** M

NEW

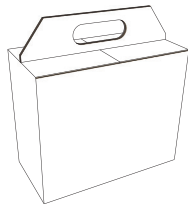

**0225** M

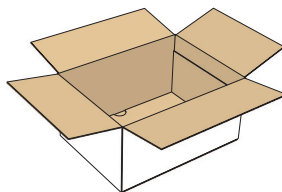

**0226** M

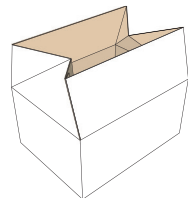

**0227 M**

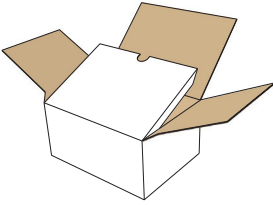

**0228 M/A**

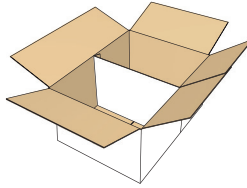

**0229 M**

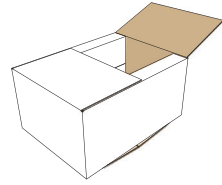

**0229.1 M**  
NEW

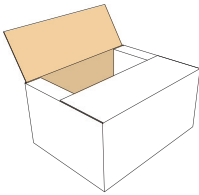

**0230 M/A**

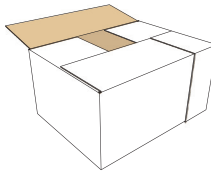

**0231 M/A**

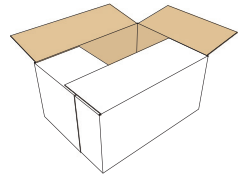

**0232 M**  
NEW

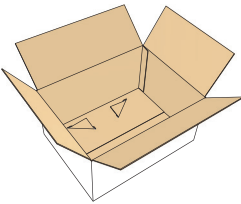

**0233 M**  
NEW

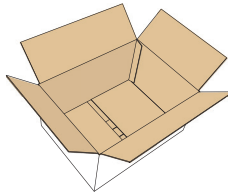

**0233.1 M**  
NEW

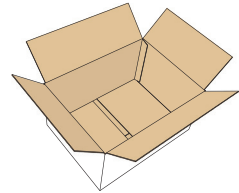

**0240 M**  
NEW



**0241 M**  
NEW

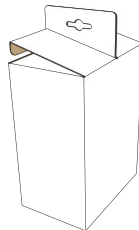

**0242 M**  
NEW

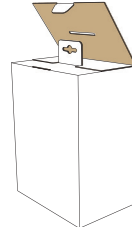

## TELESCOPIC BOXES

Telescopic boxes usually consist of more than one piece (e.g. top and bottom) and they fit over each other.

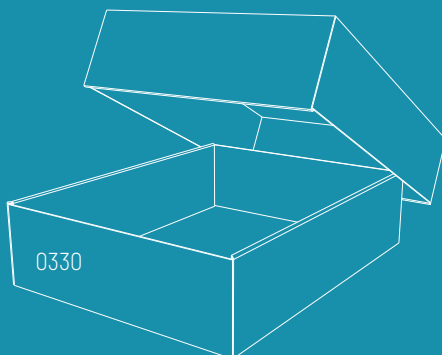
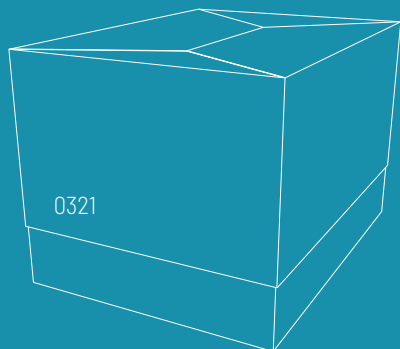
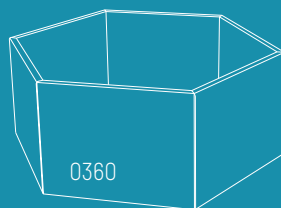
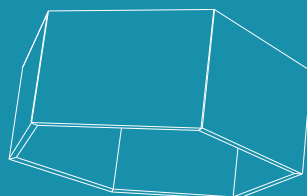
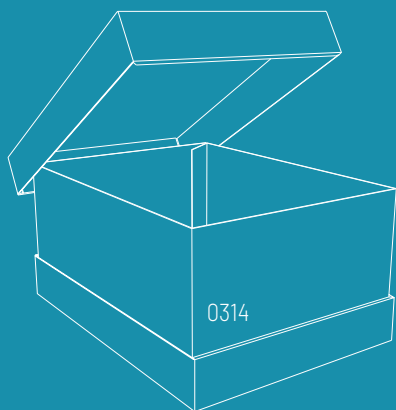

**0300** M/A

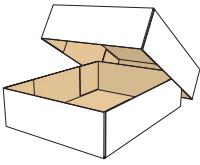

**0301** M/A

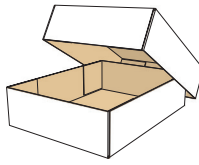

**0302** M

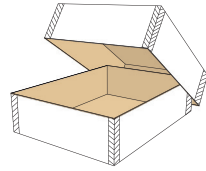

**0303** M

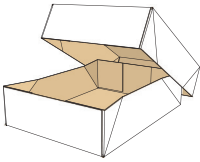

**0304** M

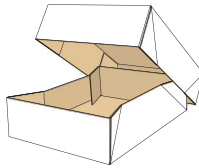

**0306** M/A

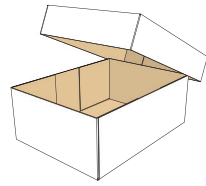

**0307** M

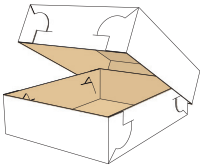

**0308** M

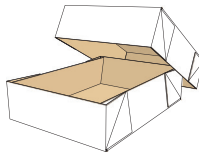

**0309** M

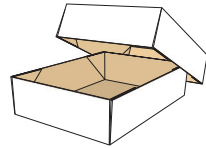

**0310** M/A

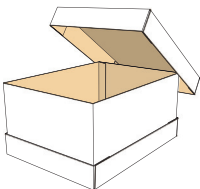

**0312** M/A

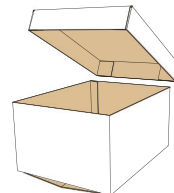

**0313** M/A

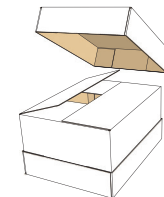

**0314** M

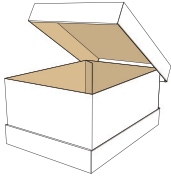

**0319** M/A  
NEW

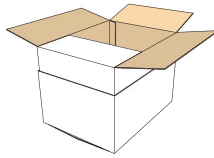

**0320** M/A



**0321** M

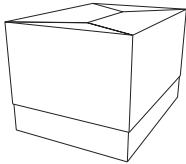

**0322** M

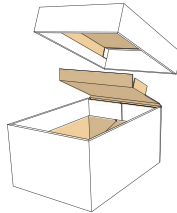

**0323** M

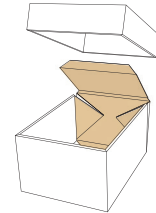

**0325** M/A

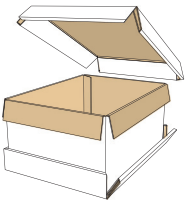

**0330** M/A

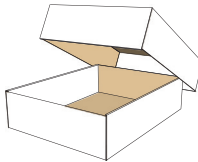

**0331** M/A

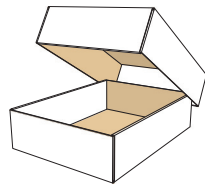

**0350** A

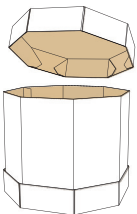

**0351** M/A



**0352** M/A

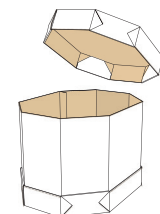

**0360 M**  
NEW

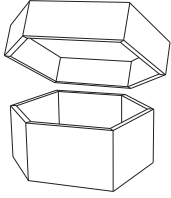

## FOLDER BOXES AND TRAYS

Folder boxes and trays are usually made from one piece of board. The bottom of the box is hinged to form two or all side walls and the cover. Locking tabs, handles, display panels, etc. can be incorporated in some designs.

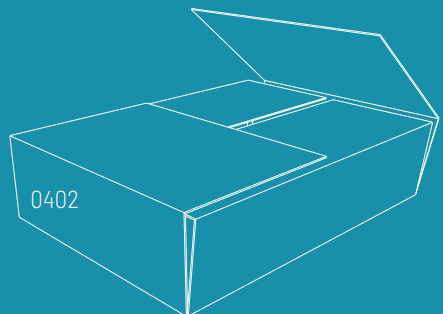
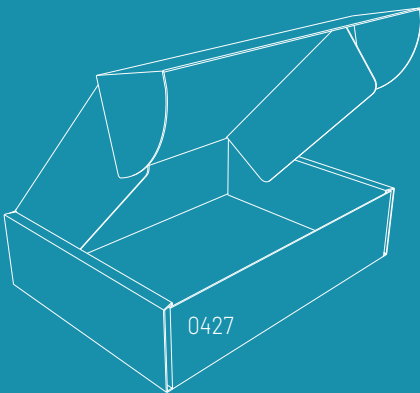
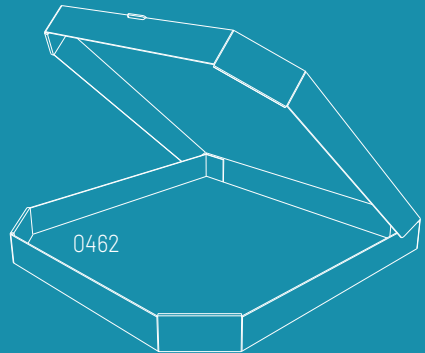
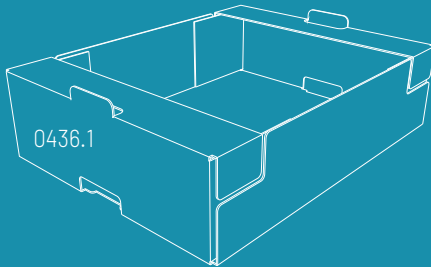

0400 M

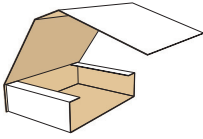

0401 M

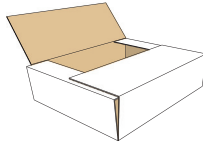

0402 M

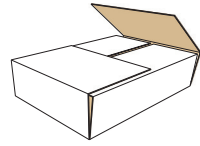

0403 M

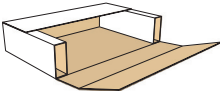

0404 M

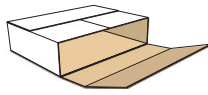

0405 M

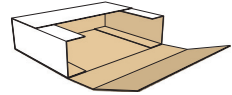

0406 A

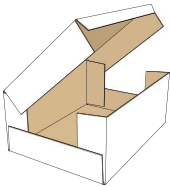

0407 M  
NEW

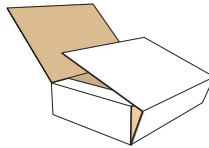

0409 M/A

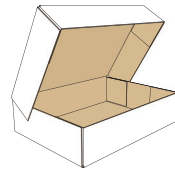

0410 M/A

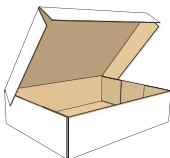

0411 M/A

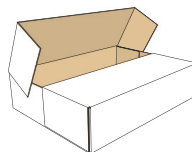

0412 M

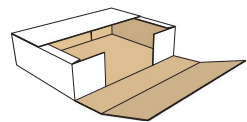



**0413** M/A

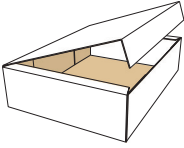

**0414** M  
NEW

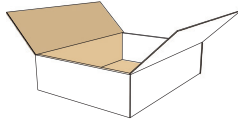

**0415** M/A

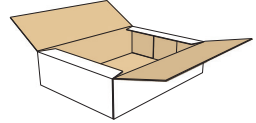

**0416** M

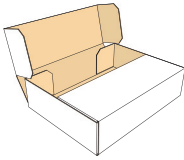

**0418** M  
NEW

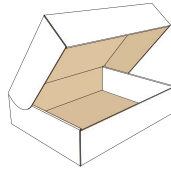

**0420** M/A

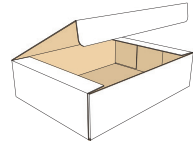

**0421** M/A

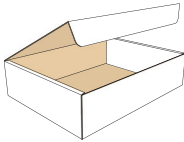

**0422** M/A

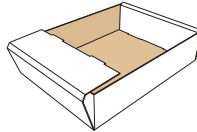

**0423** M/A

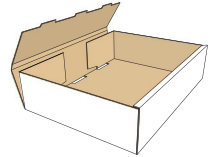

**0424** M/A

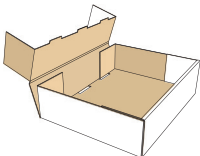

**0425** M/A

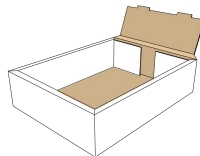

**0425.1** M/A  
NEW

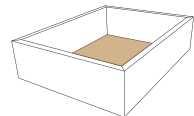

**0426 M**

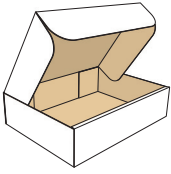

**0427 M**

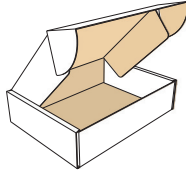

**0427.1 M**  
NEW

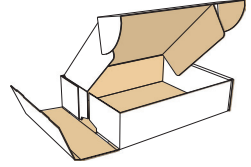

**0428 M**

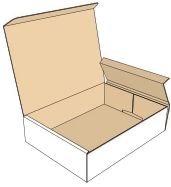

**0429 M**

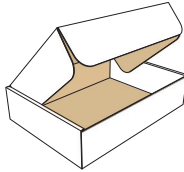

**0430 M/A**

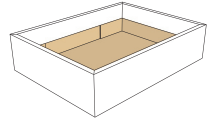

**0431 M**

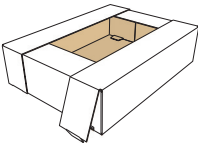

**0432 M**

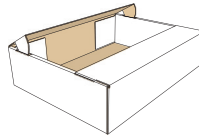

**0433 M**

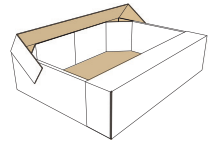

**0434 A**

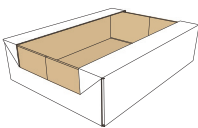

**0435 M/A**

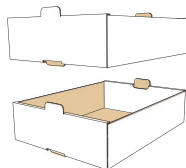

**0435.1 M/A**  
NEW

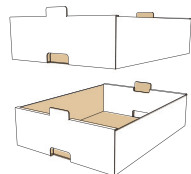

**0436 M**

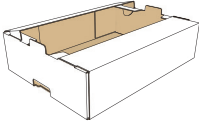

**0436.1 A**  
NEW

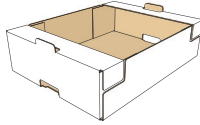

**0436.2 A**  
NEW

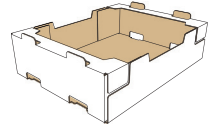

**0437 M**

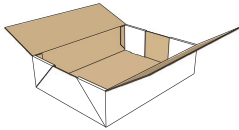

**0438 A**  
NEW

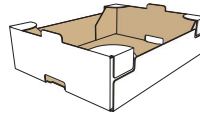

**0439 M**  
NEW

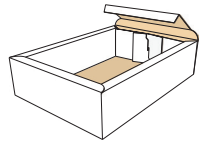

**0440 A**

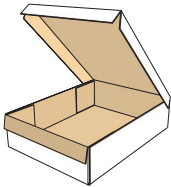

**0441 A**

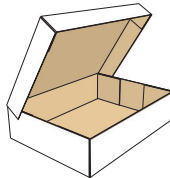

**0442 M**

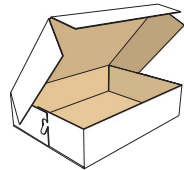

**0443 M**

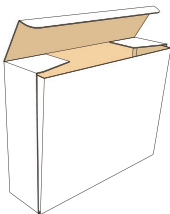

**0444 M**

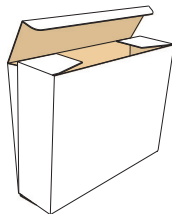

**0445 M**

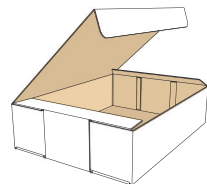

0446 A

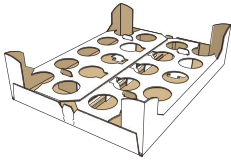

0447 M

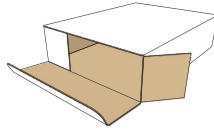

0448 M

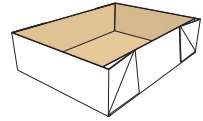

0449 M

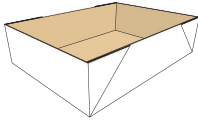

0449.1 M  
NEW

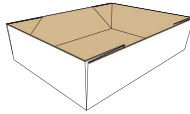

0450 M

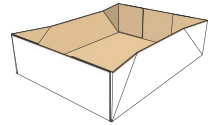

0451 M

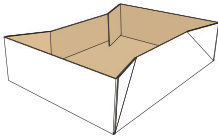

0451.1 M  
NEW

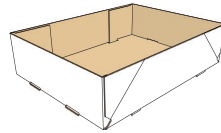

0452 A

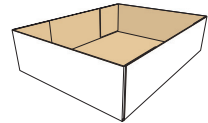

0453 A

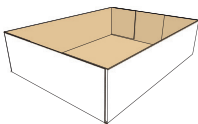

0454 M

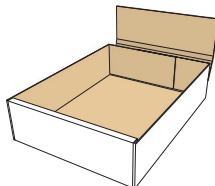

0455 M

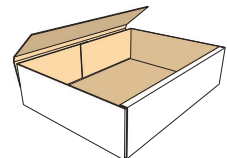

**0456 M**

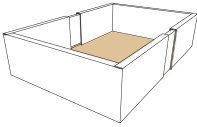

**0457 M**

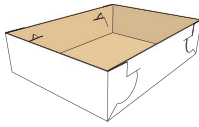

**0458 M**

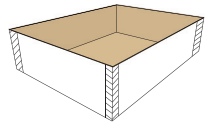

**0459 A**

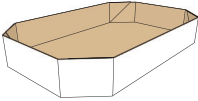

**0459.1 A**  
NEW

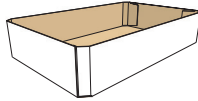

**0460 A**

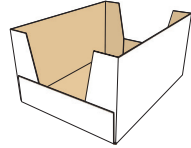

**0461 M/A**  
NEW

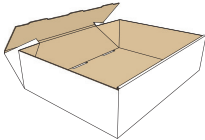

**0462 M**  
NEW

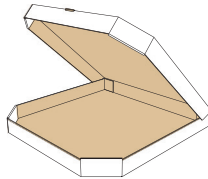

**0463 M**  
NEW

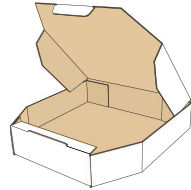

**0464 M**  
NEW

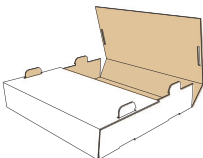

**0465 M**  
NEW

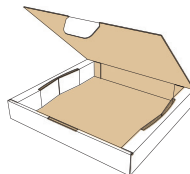

**0466 M**  
NEW

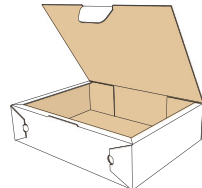

**0469 M**  
NEW

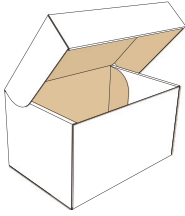

**0470 M**

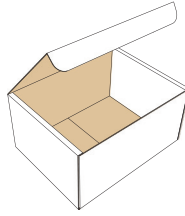

**0471 M**

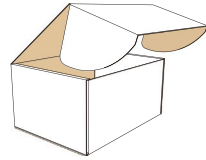

**0472 M**

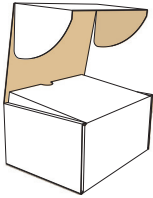

**0473 M**

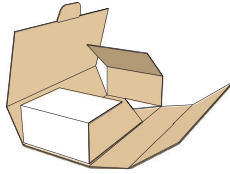

**0474 M**  
NEW

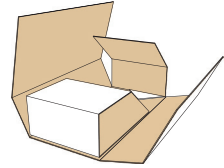

**0475 M**  
NEW

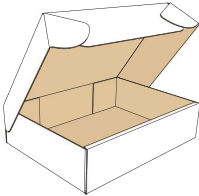

**0476 M**  
NEW

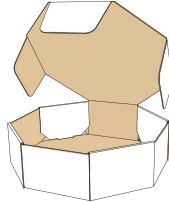

**0480 A**

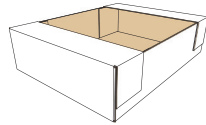

**0481 M**  
NEW

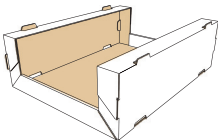

**0482 M**  
NEW

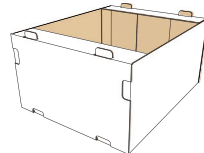

**0483 A**  
NEW

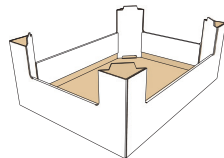

**0484 M**  
NEW

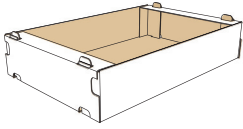

**0485 M**  
NEW

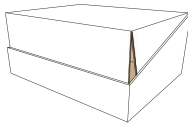





## SLIDE BOXES

Slide boxes consist of several pieces of liners and sleeves sliding in different directions into each other.

This group also includes outside sleeves for other cases.

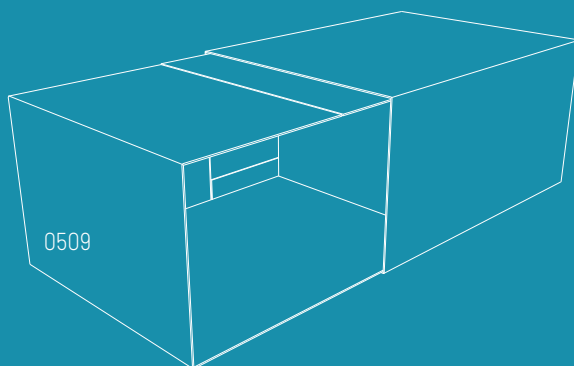
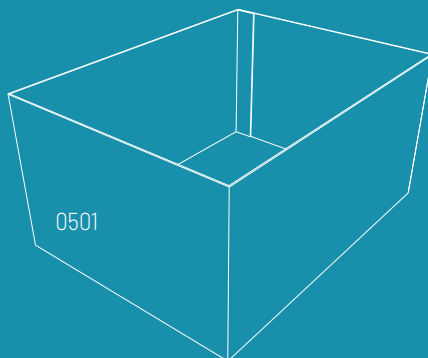
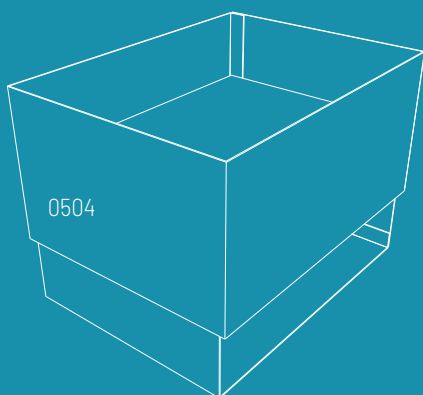

**0501** M

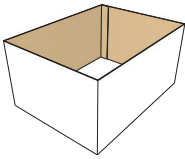

**0502** M

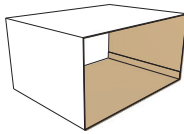

**0503** M

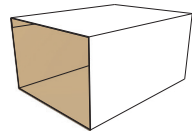

**0504** M

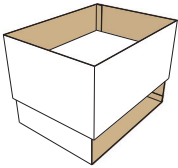

**0505** M

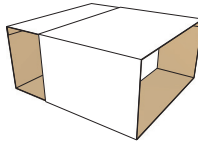

**0507** M

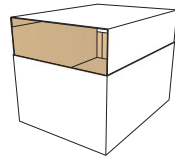

**0509** M

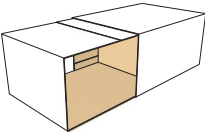

**0510** M

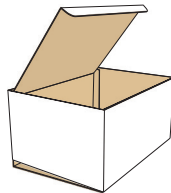

**0511** M

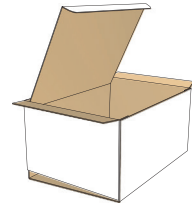

**0512** M

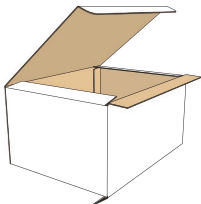

## RIGID BOXES

Rigid boxes consist of two separate end pieces and a body that require stitching or a similar operation before they can be used.

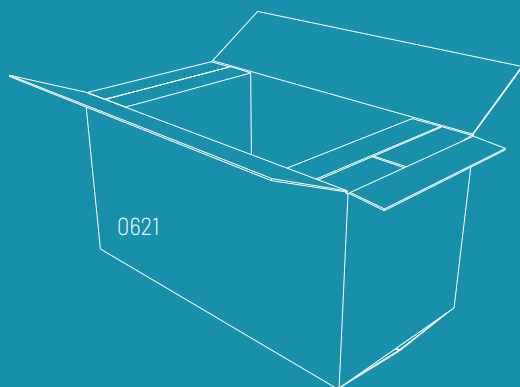
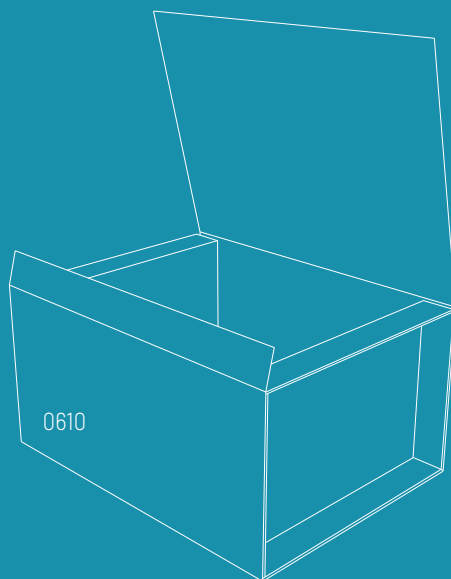
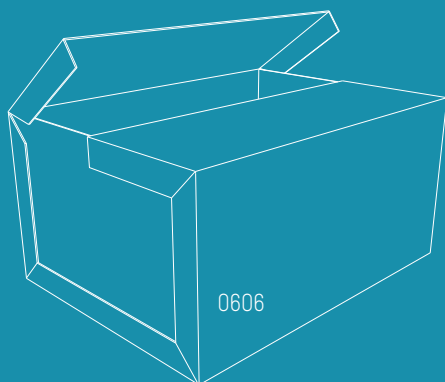

**0601** A

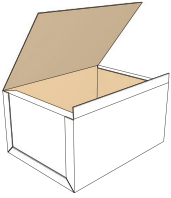

**0602** A

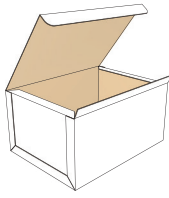

**0605** A

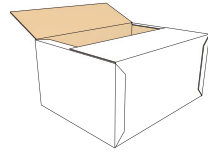

**0606** A

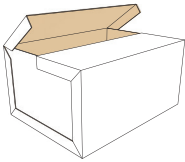

**0607** A

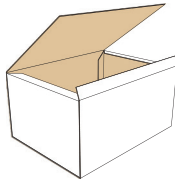

**0608** A

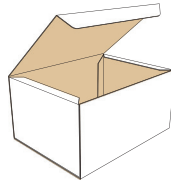

**0610** M/A

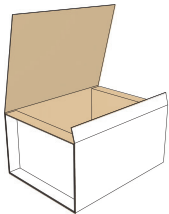

**0615** M/A

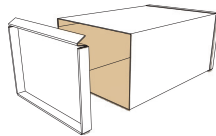

**0616** M/A

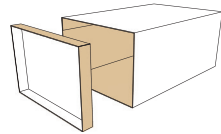

**0620** A

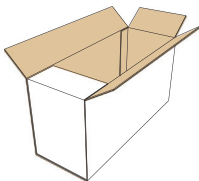

**0621** M

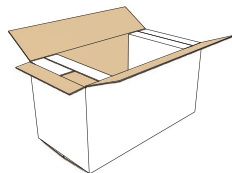

## READY-GLUED CASES

Ready-glued cases consist of basically one piece, are shipped flat and ready to use by simple assembly.

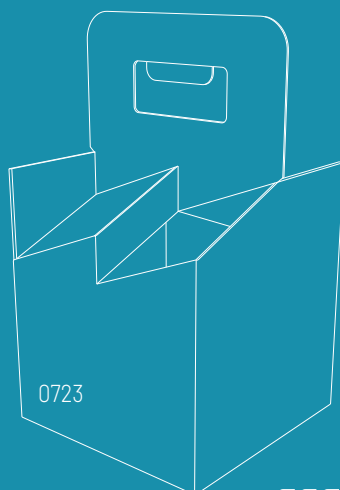
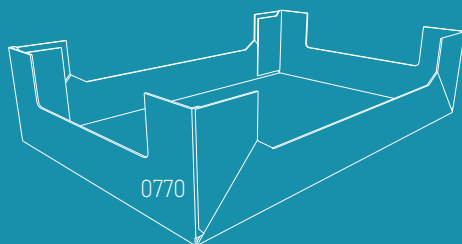
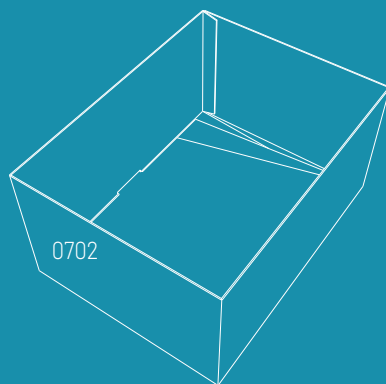
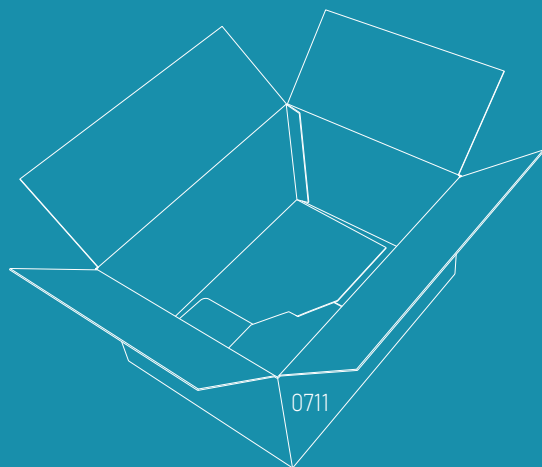

**0700 M**

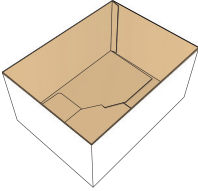

**0701 M**

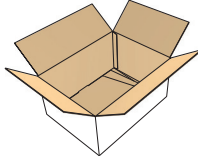

**0702 M**  
NEW

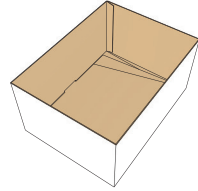

**0703 M**

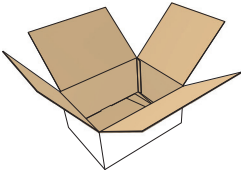

**0704 M**  
NEW

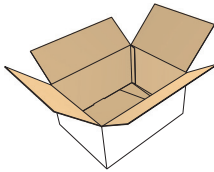

**0705 M**  
NEW

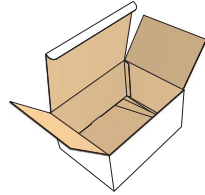

**0706 M**  
NEW

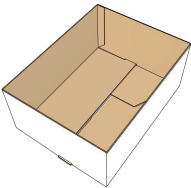

**0707 M**  
NEW

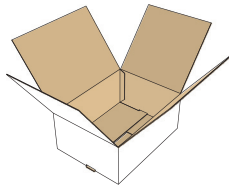

**0708 M**  
NEW

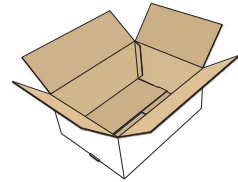

**0709 M**  
NEW

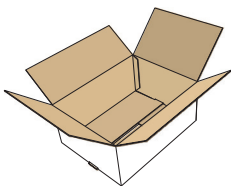

**0710 M**  
NEW

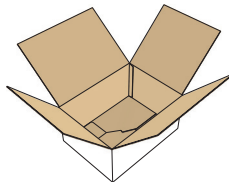

**0711 M**

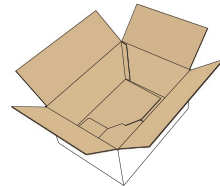

**0712 M**

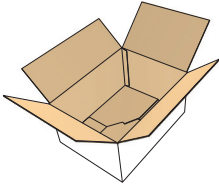

**0713 M**

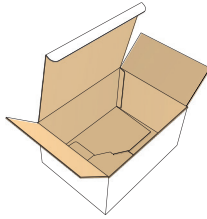

**0714 M**

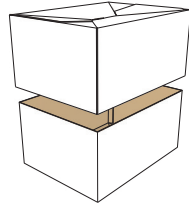

**0715 M**

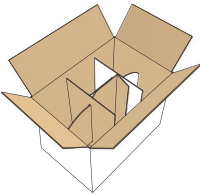

**0716 M**

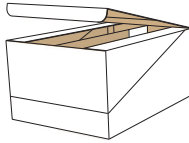

**0717 M**

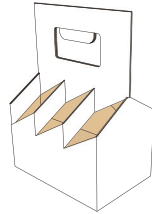

**0718 M**

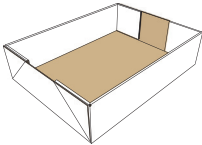

**0719 M**

**NEW**

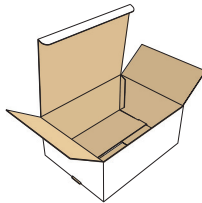

**0720 M**

**NEW**

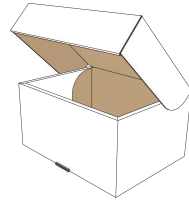

**0721 M**

**NEW**

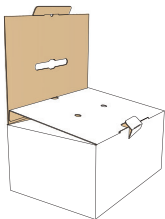

**0722 M**

**NEW**

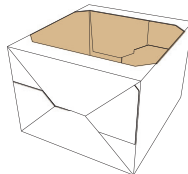

**0723 M**

**NEW**

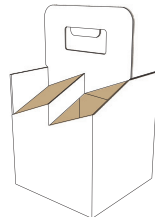

**0724 M**  
NEW

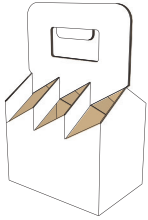

**0725 M**  
NEW

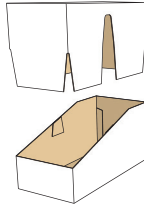

**0726 M**  
NEW

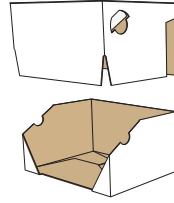

**0727 A**  
NEW

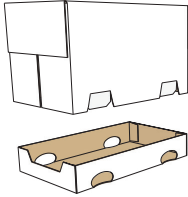

**0728 M**  
NEW

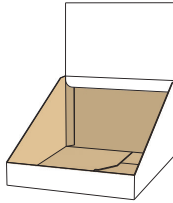

**0730 M**  
NEW



**0740 M**  
NEW

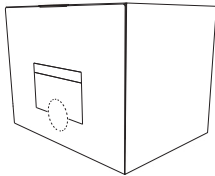

**0747 M**

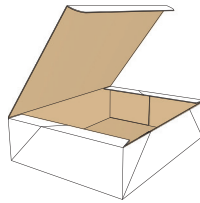

**0748 M**

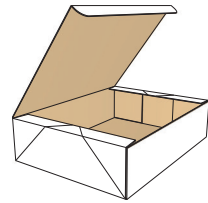

**0751 M**

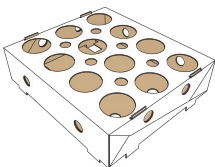

**0752 M**

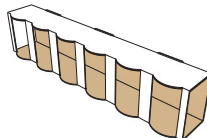

**759 M**

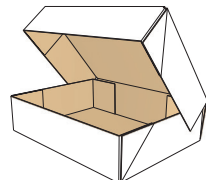



**0761** M

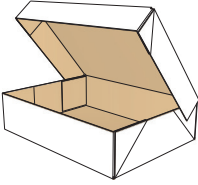

**0770** M

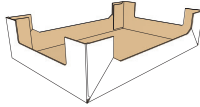

**0771** M

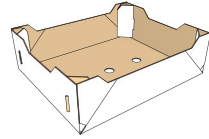

**0772** M

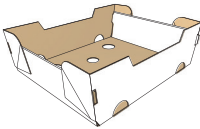

**0773** M

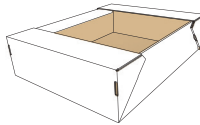

**0774** M

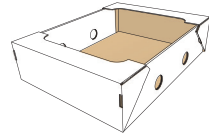



## RETAIL AND E-COMMERCE PACKAGING

Retail and e-commerce packaging category shows the typical styles used for Point of Sale (POS) displays and trays as well as styles for the online trade.

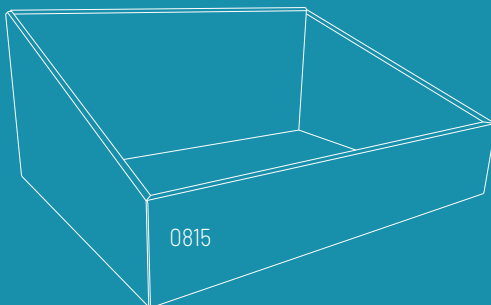
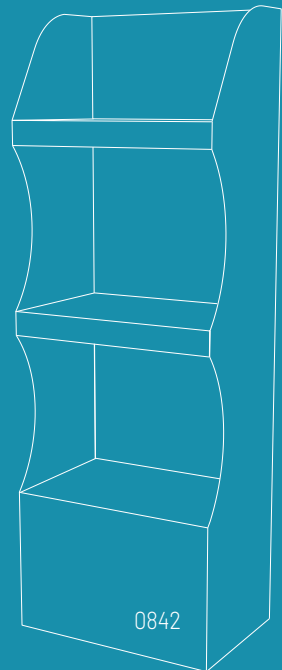
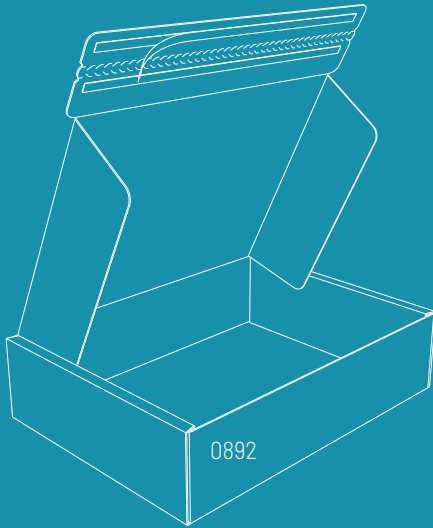

**0801 M**  
NEW

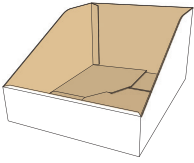

**0802 M/A**  
NEW

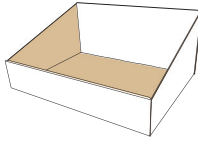

**0803 M**  
NEW

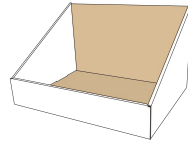

**0804 M**  
NEW

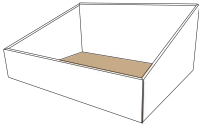

**0808 M**  
NEW

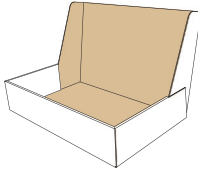

**0809 M**  
NEW

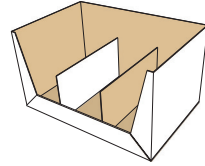

**0815 M**  
NEW

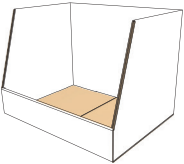

**0816 M**  
NEW

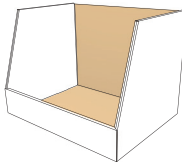

**0817 M**  
NEW

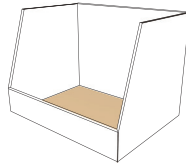

**0818 M**  
NEW

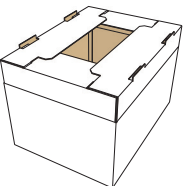

**0819 M**  
NEW

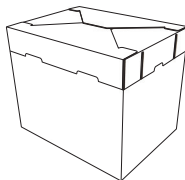

**0825 M**  
NEW

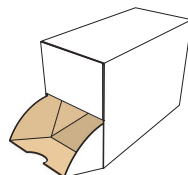

**0826 M**  
NEW

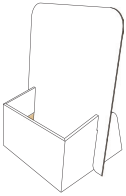

**0830 M**  
NEW

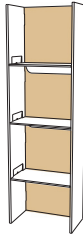

**0831 M**  
NEW

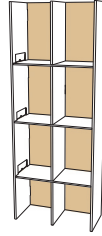

**0832 M**  
NEW

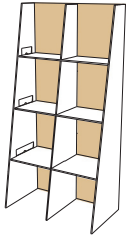

**0833 M**  
NEW

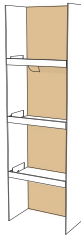

**0834 M**  
NEW

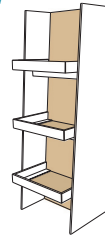

**0840 M**  
NEW

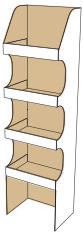

**0841 M**  
NEW

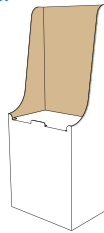

**0842 M**  
NEW

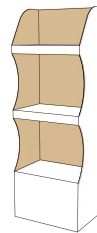

**0843 M**  
NEW

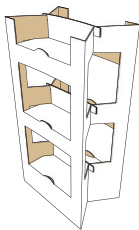

**0845 M**  
NEW



**0846 M**  
NEW



**0847 M**

NEW

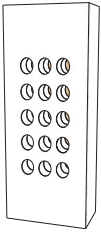

**0848 M**

NEW

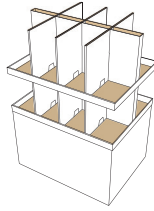

**0849 M**

NEW

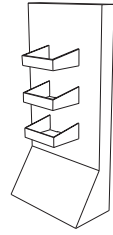

**0850 M**

NEW

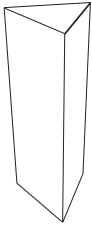

**0851 M**

NEW

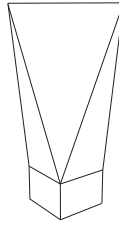

**0852 M**

NEW



**0853 M**

NEW

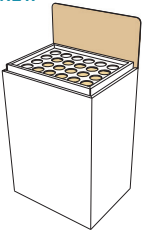

**0854 M**

NEW

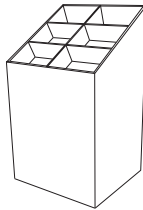

**0858 M**

NEW

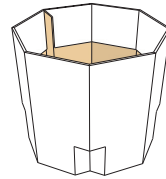

**0859 M**

NEW

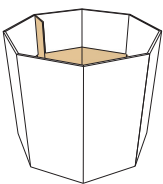

**0860 M**

NEW

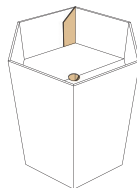

**0861 M**

NEW

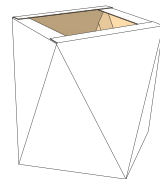

**0865 M**  
NEW

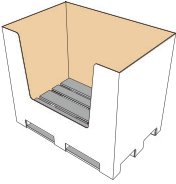

**0866 M**  
NEW

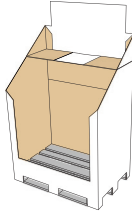

**0870 M**  
NEW

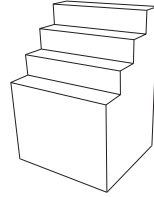

**0871 M**  
NEW

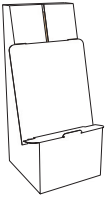

**0872 M**  
NEW

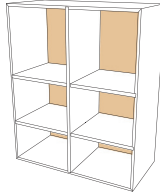

**0873 M**  
NEW

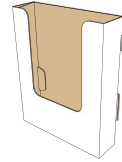

**0874 M**  
NEW

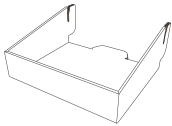

**0880 M**  
NEW

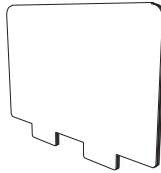

**0881 M**  
NEW

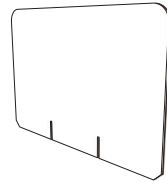

**0882 M**  
NEW

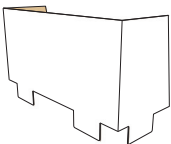

**0885 M**  
NEW

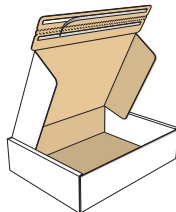

**0886 M**  
NEW

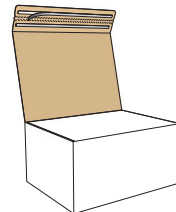

**0887 M**  
NEW

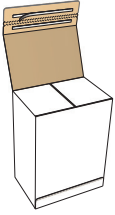



## INTERIOR FITMENTS

Interior fitments such as inside liners, pads, partitions, dividers, etc. whether integrated in the box design or as separate items. Any shown number of panels is arbitrary and may be increased or decreased as required.

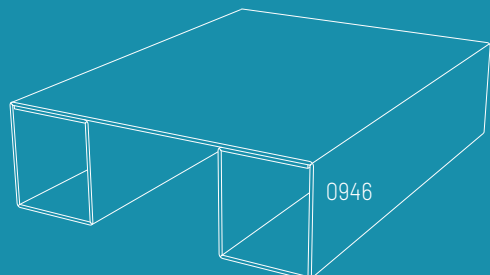
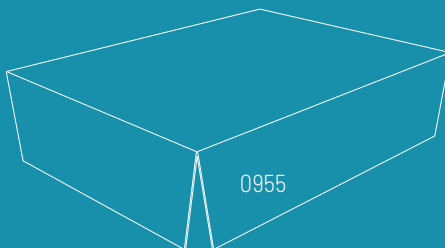
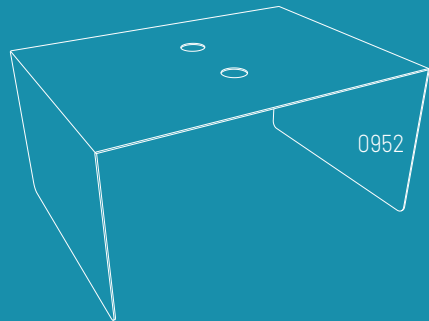
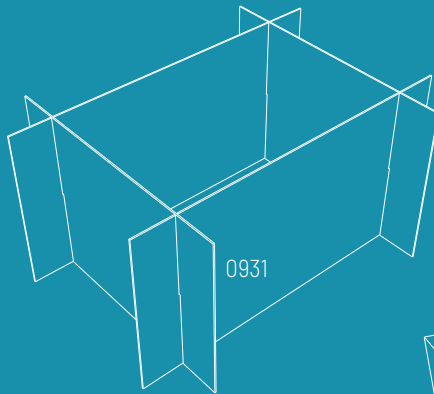

**0900** M/A

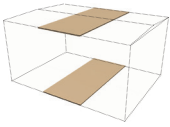

**0901** M/A

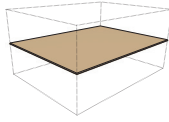

**0902** M/A

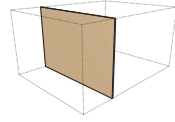

**0903** M/A

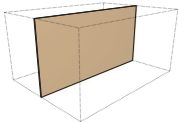

**0904** M/A

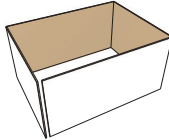

**0905** M/A

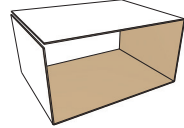

**0906** M/A

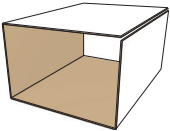

**0907** M/A

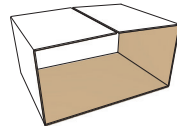

**0908** M/A

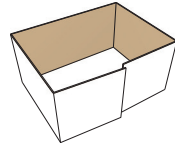

**0909** M/A

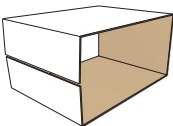

**0910** M/A

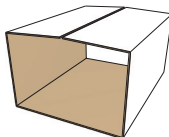

**0911** M/A

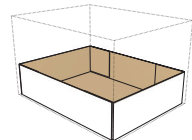

**0912** M/A  
NEW

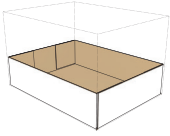

**0913** M

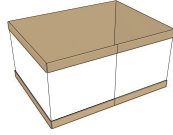

**0914** M

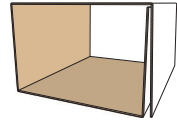

**0920** M

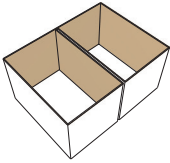

**0921** M

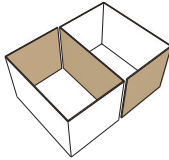

**0929** M

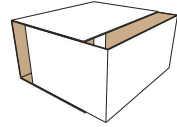

**0930** M

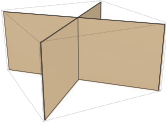

**0931** M

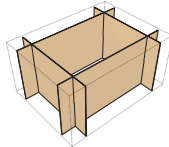

**0932** M

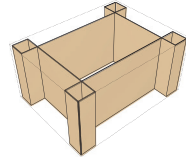

**0933** M



**0934** M

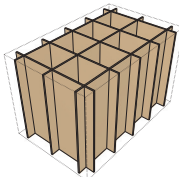

**0935** M

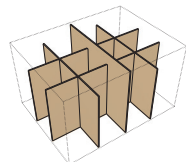

**0936 M**  
NEW

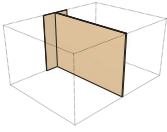

**0937 M**  
NEW

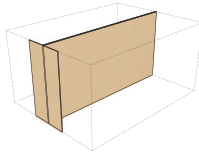

**0938 M**  
NEW

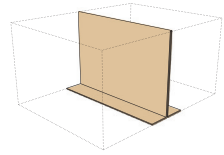

**0939 M**  
NEW

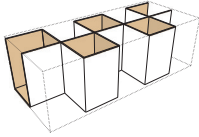

**0940 M**

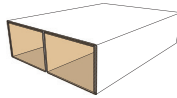

**0941 M**

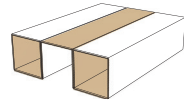

**0942 M**

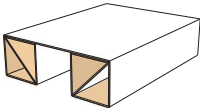

**0943 M**

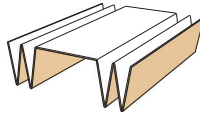

**0944 M**

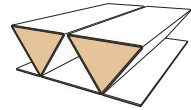

**0945 M**

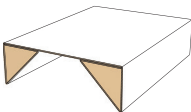

**0946 M**

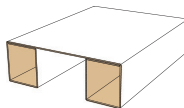

**0947 M**

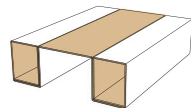

**0948 M**

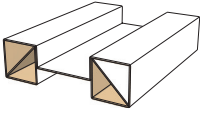

**0949 M**

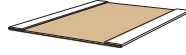

**0950 M**



**0951 M**

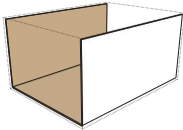

**0952 M/A**  
NEW

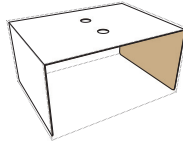

**0953 M/A**  
NEW

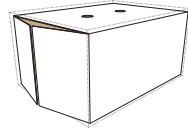

**0954 M**  
NEW

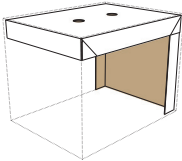

**0955 M**  
NEW

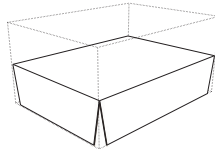

**0960 M**  
NEW

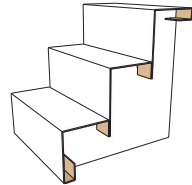

**0965 M**

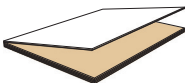

**0966 M**

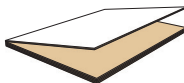

**0967 M**



**0970 M**

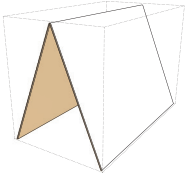

**0971 M**

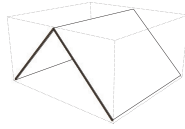

**0972 M**

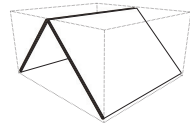

**0973 M**

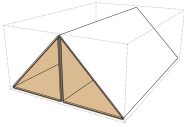

**0974 M**

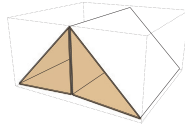

**0975 M**

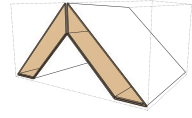

**0976 M**

