

2021

EUROPEAN DATABASE FOR CORRUGATED BOARD LIFE CYCLE STUDIES

Report prepared by RISE Bioeconomy on behalf of FEFCO and CCB

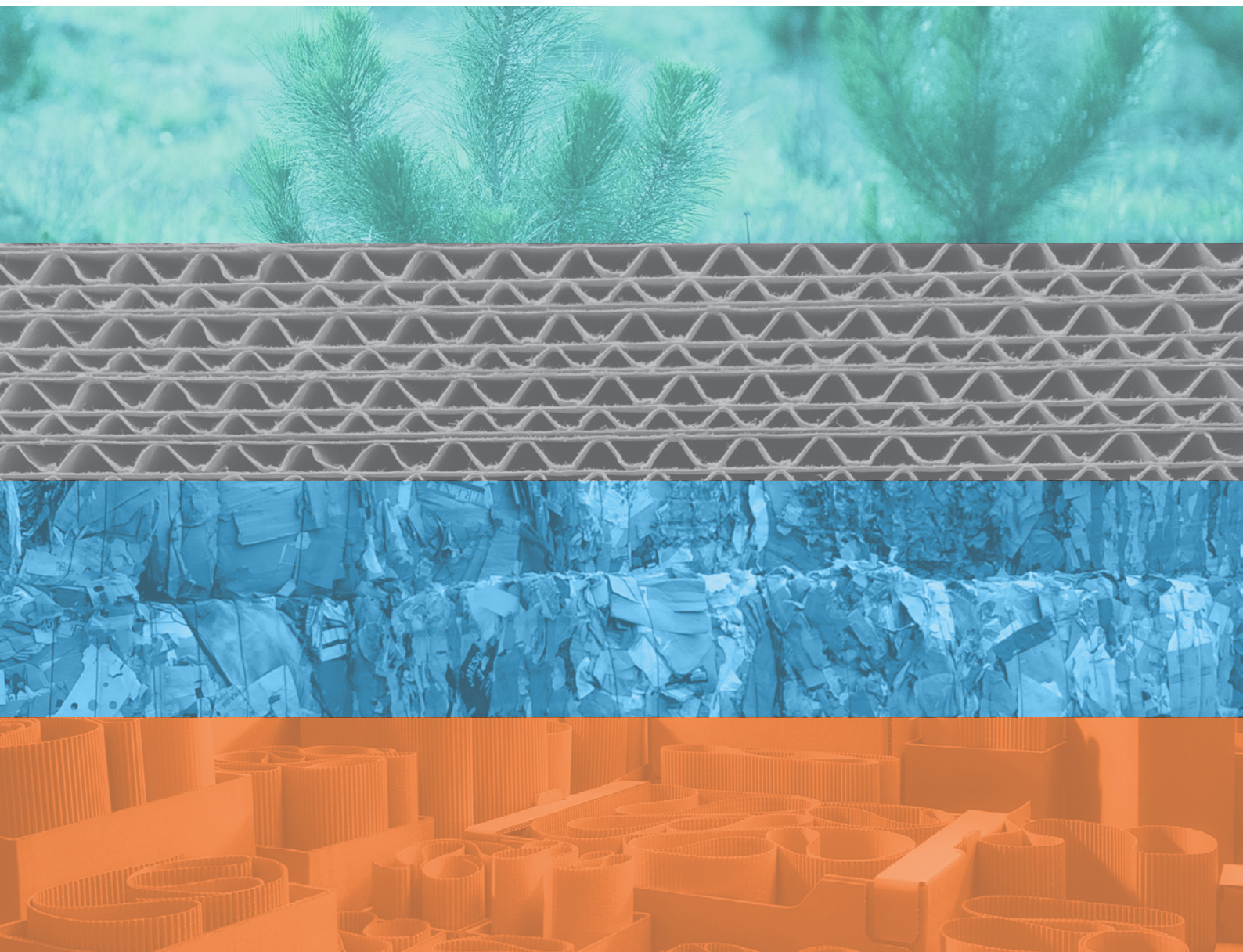

CONTENTS

FOREWORD	3
DESCRIPTION OF THE PRODUCT SYSTEM	5
Paper production process	5
Corrugated board production	7
Corrugated base papers and corrugated board	9
METHODOLOGY QUESTIONS	12
Boundaries and declared unit	12
System boundaries for corrugated base papers	14
System boundaries for corrugated board and boxes	16
The closed-loop approach	18
DATA DESCRIPTION	21
Questionnaire Data collection for corrugated base papers	21
Data collection for corrugated board and box production	21
Weighted averages	21
Material inputs	22
Material outputs	23
Energy input and output	24
Water inputs and outputs	25
Transport	25
Emissions to air	26
Emissions to water	27
DATA	29
Coverage and comparability of the datasets	29
Production trends unique to 2020	29
Relationship to the Product Environmental Footprint (PEF)	30
RESULTS	31
Life cycle inventory for corrugated board 2020	31
ADDITIONAL INFORMATION ON ENERGY AND FUELS	35
Internal fuels	35
Year-on-year trends	36
Sustainable forest management	36
PEER REVIEW	37
DEFINITIONS	38
ANNEX 1	39
ANNEX 2	43

FOREWORD

Every three years FEFCO (European Federation of Corrugated Board Manufacturers) and CCB (Cepi ContainerBoard¹) issue a report and database of gate-to-gate life cycle inventory data for the production of corrugated base papers and corrugated products. The intention is to make available high quality and transparent LCI data for use in life cycle studies.

Over the course of multiple iterations of the project a robust process has been developed in which the data provided is processed and checked by both LCA practitioners and industry experts. The process and data are then subjected to an independent peer review by ifeu – Institute for Energy and Environmental Research Heidelberg GmbH, Heidelberg, Germany, a leading research institution with experience of life cycle data and methods as applied in the paper and board sector.

The Annex of the report contains environmental data of the production of

- Corrugated base papers from primary fibres: kraftliner, white top kraftliner and semi chemical fluting (based on data supplied by members of CCB)
- Corrugated base papers from recovered papers: testliner, white top testliner and recycled fluting (sometimes referred to as Wellenstoff)(based on data supplied by members of CCB)
- Corrugated board products (based on data supplied by members of FEFCO).

The data in this tenth edition of the report represents the weighted averages of the inputs and outputs from the production sites per tonne paper and per tonne of corrugated board product for the year **2020**. The database handles the production sites as a black box. Details of the different processes in the production site are not provided. Emissions etc. originating from production of resources consumed, energy production outside the mill or corrugated plant, transport and waste treatment are not included in the datasets, but the impacts of these additional unit processes can be added by the user to facilitate full cradle-to-gate or cradle-to-cradle life cycle studies.

The data collected for this study covers a significant proportion of the sector. For semi chemical fluting and kraftliner, the collected data represents about 84% of the total annual production of corrugated base papers from primary fibres in Europe, whilst the data for the production of testliner (including white top testliner) and recycled fluting (wellenstoff) were collected from mills, together producing about 71% of the total annual production of corrugated base papers from recovered paper in Europe. Data for corrugated board production covered approximately 73% of the total annual production in Europe. The high levels of data provision mean that the datasets presented in Table 3 and in the Annex are highly representative of the practices and subsequent overall environmental performance of the sector.

The report is available for interested parties on the condition that the data in this report may only be used for environmental studies such as Life Cycle Inventory Analysis, Life Cycle Impact Assessment as separate steps or as a whole Life Cycle Assessment.

The database may only be used for environmental studies regarding product development and improvement and the comparison of the entire system of corrugated board packaging with that of other materials. **The database cannot be used for comparisons between the production of primary fibre and recovered fibre-based materials as such.**

LCA methodology, with its systematic, scientific approach, gives an insight into the environmental impact that a product may have **on a case-by-case basis**.

When LCA data is used to make comparative studies, a specific scenario is chosen and the result can and will vary depending on various parameters. It should be clearly understood that, whatever the outcome of a comparative study, the conclusion should not and cannot be generalized.

It is therefore not recommended to use a single message from a comparative LCA study as the basis for lobbying activities.

According to ISO 14044, allocation of the impacts of primary fibre production (the cradle) and waste treatment

¹ In the past, the project was a joint undertaking by three associations FEFCO, GEO (European Association of makers of Corrugated Base Papers) and ECO (European Containerboard Organisation). GEO and ECO have merged to become Cepi ContainerBoard.



(the grave) of wood fibre to the phases in between the cradle and the grave of the life cycle should be avoided, wherever possible. In our case this is done by expanding the product system and considering the expanded system with a closed-loop approach.

FEFCO and CCB are committed to ongoing and regular updates of the database. The user of the database should therefore check whether it is the latest edition of the database report prior to using the information enclosed. The latest version will always be available online or through direct contact with either of the Associations.

We would like to thank all participants from the industry for providing the necessary input from their plants. Collecting, processing and checking the data is a significant undertaking. The high level of ongoing participation of the membership base of both organisations is highly appreciated.

We are also grateful for the positive response and valuable feedback and comments we have received from users of the previous editions of the database and reports. **We welcome comments on this report and feedback on the experiences of users of the database. Such feedback can only help to further improve the quality and value of future updates!**

May 2022

Eleni Despotou
FEFCO

Klaus Spielmann
Cepi ContainerBoard

DESCRIPTION OF THE PRODUCT SYSTEM

PAPER PRODUCTION PROCESS

Liner and fluting papers can be manufactured from primary wood fibres from sustainably managed forests and/or from recovered fibres from paper for recycling. As a general rule, kraftliner and semi chemical fluting are manufactured from predominantly primary fibres whereas testliner and recycled fluting are predominantly manufactured from recovered fibres.

Production of liner and fluting is typically performed at an integrated pulp and papermill (meaning that the pulp and the paper are produced at one single site, and the wet pulp is pumped directly to the paper machine with no additional drying or transport required).

For mills utilising primary wood fibre, most of the wood is delivered in the form of pulpwood logs. A proportion is also brought in as wood chips, a by-product of nearby sawmills. The pulpwood logs have to be debarked and chipped before pulping. For Kraftliner production, the kraft pulping process is used. This is a highly alkaline cooking process with caustic soda and sodium sulphide as active cooking chemicals. The cooking takes place in a digester at high pressure and a temperature of 150 -170 oC. The pulp yield is normally around 55% (i.e. 1000 kg of dry wood gives 550 kg of pulp).

For semi chemical fluting production, the wood chips are converted into pulp by the semi chemical cooking process. It is a slightly alkaline cooking process most commonly using sodium sulphite and sodium carbonate as active cooking chemicals. The pulp yield is normally around 80%.

The spent cooking liquor is drained off and washed out from the pulp. It contains the wood substance dissolved during the cooking together with the spent cooking chemicals. The spent liquor is concentrated and burnt as a fuel for energy production and recovery of cooking chemicals. The pulp produced is defiberized in refiners, screened and washed before being sent to the paper mill.

For mills utilising recovered fibres, the main recovered paper grade utilised for manufacture of testliner and recycled fluting is old corrugated cases 2, meaning that most of the fibres are recycled in a closed loop system.

The bales of recovered paper are submerged in water and the mixture is agitated so that the paper is broken up to form a pumpable suspension. Large non-paper components such as pieces of plastics, wood, metal and textiles are removed using a "ragger" or "junker" and smaller remaining non-paper components are removed by screening and cleaning. The hot pulp may also undergo a dispersing treatment, in which contaminants such as hot melt, wax, ink and coating binders loosen from the fibres and together with small fragments of paper are reduced to fine particles which are no longer visible. Pulp for recycled fibre-based paper for corrugated packaging does not normally undergo a deinking process.

For pulps from both primary fibres and recycled fibres, functional chemicals, fillers and other pulps can be added to give the final paper the properties required.

Figure 3 shows an example of the production stages for a typical paper machine. The wet stock passes through one or two headboxes onto the paper machine. The paper web is formed from the head box onto the wire and dewatered primarily by the action of gravity and vacuum. Further dewatering by mechanical means takes place in the press section where water is taken out of the sheet by pressing between felts. The final drying takes place in the drying section of the paper machine where the sheet runs against steam heated cylinders to get its final dryness of 91-93%. The collected water is reused for diluting the thick stock coming from the stock preparation.

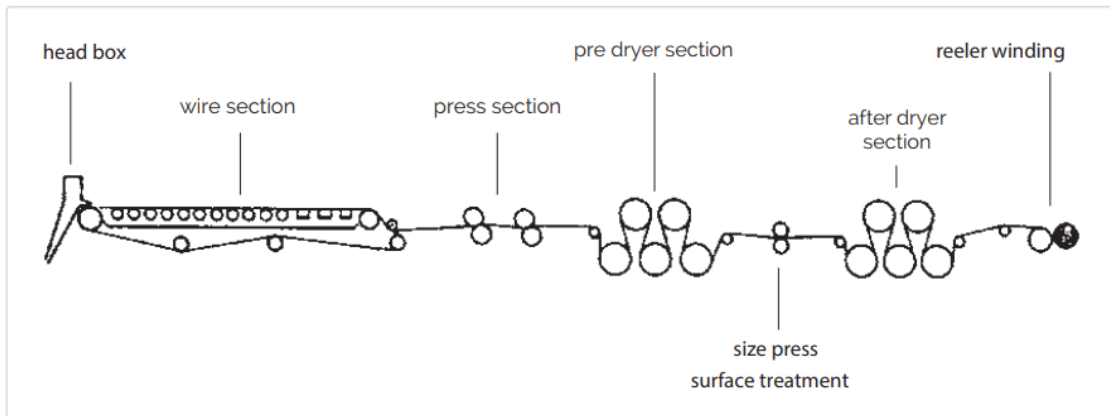

Figure 3
Example of paper machine for containerboard grades

Semi chemical fluting is a paper with just one ply and therefore the paper machine has one headbox and one wire. Kraftliner is normally a two-ply product and therefore requires a paper machine with two headboxes and usually two wires. The base brown ply contains the internal machine broke pulp in addition to wood fibres from the usually integrated pulp production and could also contain recycled paper pulp. The top ply is normally wood pulp from the integrated pulp production that is more refined and cleaner to give the top surface the right characteristics and printability. For white surface grades bleached fibres are used for the top ply.

Testliner mostly consists of two plies of paper. Different mixes of recovered pulp stock will be used in each layer. Generally, a better grade of mix is used for the upper layer for reasons of appearance and strength. In order to increase its strength testliner receives a surface treatment in the size press. This involves the application of a starch solution to one or both sides of the sheet. The top ply of testliner is given an even, mostly brown colour by colouring the mass or by means of the size press treatment. This colouring is never given to white top testliners. The addition of special additives (in the mass or by means of the size press) makes it possible to produce testliners with special properties, including extra water-repellent, low-germ and anti-corrosion grades.

Recycled fluting can be a one-ply or two-ply product. Usually, a size press treatment with a starch solution is applied in-line on the paper machine in order to obtain sufficient strength and stiffness properties

After the paper machine there is a slitter winder where the jumbo reel from the paper machine is rewound and cut down to customer reel formats according to customer orders. These reels are weighed, marked, labelled and prepared for shipment to the customer, the corrugated board industry.

Corrugated base papers comprise the largest share of paper and board production in Europe, representing 37% of total paper and board production. European production of corrugated base papers in 2020 stood at 30.1 million tonnes³. The majority of product is produced from recovered fibres. 88% of corrugated packaging is derived from recycled content. Corrugated base papers have a paper for recycling utilisation rate of 94% and use 61% of total paper for recycling volumes used by the industry⁴.

Table 1 summarises the base paper consumption for corrugated board in 2020.

³ CCB statistics

⁴ CEPI Key Statistics 2020

Table 1 Base Paper Consumption for Corrugated Board in Europe 2020 (from CCB Statistics)

Million tonnes	Total	Fibre composition	
		Primary	Recycled
Kraftliner	4.4	3.2	1.2
Testliner	12.5		12.5
Other recycled liner (Schrenz)	1.0		1.0
Semi chemical fluting	0.6	0.5	0.1
Recycled fluting	11.6		11.6
	30.1	3.7	26.4
		12%	88%

CORRUGATED BOARD PRODUCTION

Corrugated board is made from a combination of flat sheets of paper (called “liners”) glued to a crenulated corrugated inner medium (called “fluting”). These layers of paper are assembled to one another (typically using a starch glue) in a way which gives the overall structure a better strength.

Most commonly, a single layer of fluting is sandwiched between two liners. This type of construction, as shown in Figure 1, is known as single wall corrugated board.

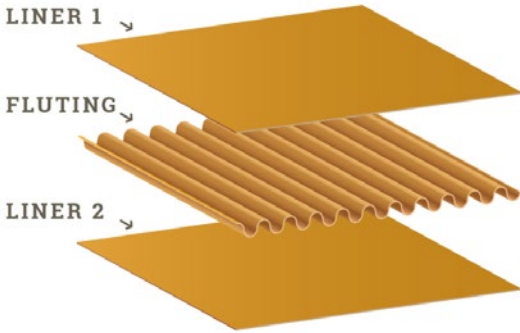

Figure 1: Single wall corrugated board

Double wall and triple wall boards are also available on the market. A corrugated board grade called single face board consists of corrugated medium glued to only one flat liner (see Figure 2).

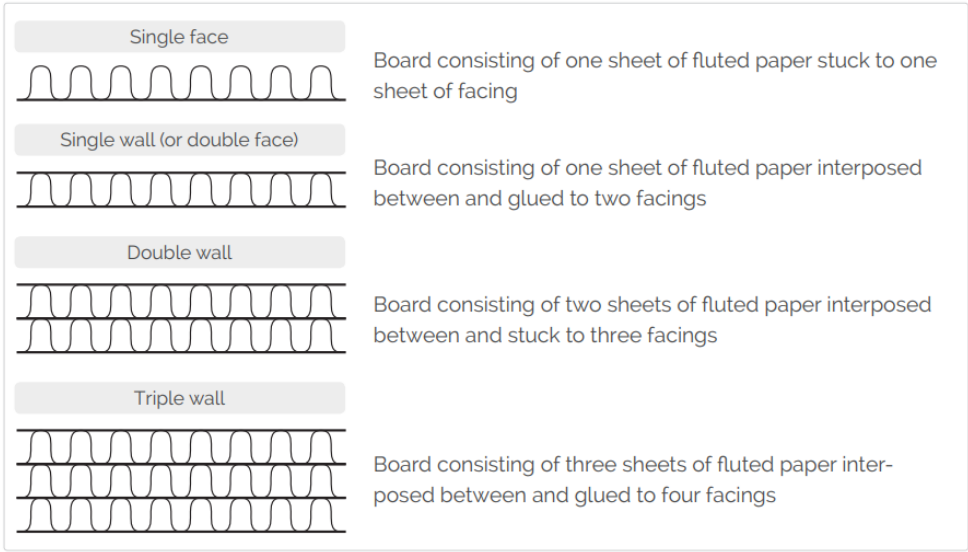

Figure 2: Corrugated board constructions



This ingenious construction forms a series of connected arches, a geometric form that is well known for its ability to support strong weights. This structure gives corrugated board considerable rigidity and resistance. The air circulating in the flutes also serves as an insulator. These properties of strength and insulation mean that, when converted into boxes, corrugated board provides excellent protection of the packed goods against damage and temperature variations.

The corrugated board industry is made up of three types of plant:

- Sheet plants – these take in liner and fluting paper and produce corrugated board in sheets which is sold on to box plants for production of boxes
- Box plants – these take in sheets of corrugated board and convert them into corrugated boxes
- Integrated plants – these take in liner and fluting paper and produce corrugated board, which they then convert into corrugated boxes. They may also purchase some corrugated board in sheets from other sheet plants to supplement their own production. Conversely, they may also sell some corrugated board in sheets to other box plants.

The majority of production in Europe is in integrated plants.

Reels of fluting and liner are fed into a machine called a corrugator (Figure 4). The fluting paper is conditioned with heat and steam and fed between large corrugating rolls that give the paper its fluted shape. Starch is applied to the tips of the flutes on one side and the inner liner is glued to the fluting. The corrugated fluting medium with one liner attached to it is called single face web and this travels along the machine towards the double backer, where the single face web meets the outer liner and forms corrugated board. A number of layers of single faced web may be built up to produce double and triple wall corrugated board (Figure 2). The corrugated board is slit into the required widths and cut into sheets which are then stacked or palletised.

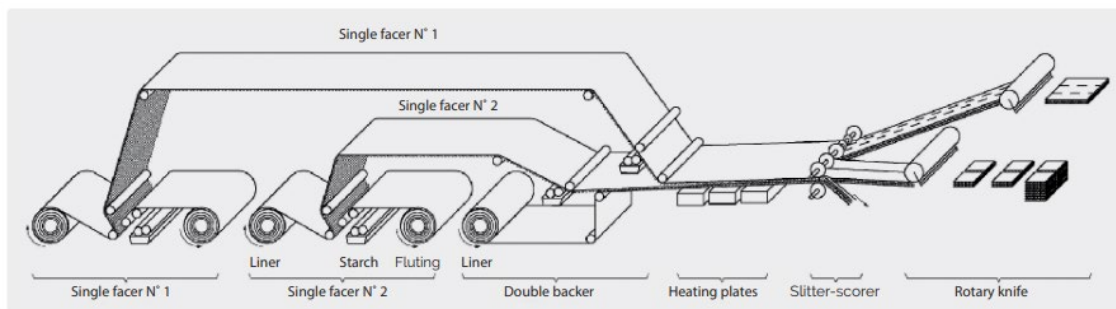

Figure 4: Corrugated board production

The main conversion steps when converting corrugated sheets into corrugated boxes include printing, slotting, folding and gluing. The printing and gluing steps may be absent, depending on the specific design of the corrugated box. Depending on design, corrugated boxes are typically delivered to the end user as flat blanks (Figure 6) ready for erection (Figure 7). This ensures space efficiency during distribution.

Most boxes are printed in one or more colours to identify the product they are going to contain, the product manufacturer, the box manufacturer and other information regarding the distributed goods. Different converting operations are carried out according to the customer's specification and according to the type of packaging. The two main categories are the regular slotted box and the die-cut box. The latter concerns packaging that requires a very precise cutting and which can have a complex design.

Regular slotted boxes are usually produced with an in-line flexographic Printer/Slotter/ Folder/Gluer which, in one operation, prints, cuts, folds and glues the board into its final shape. The die-cut boxes are manufactured on a die-cutter (rotary or flatbed) which cuts and creases the board. After converting, the corrugated packaging is put on a pallet and delivered to the customer.

CORRUGATED BASE PAPERS AND CORRUGATED BOARD

This study covers the production of the following grades of corrugated base papers⁵:

- Kraftliner, including brown kraftliner, white top kraftliner and white coated kraftliner
- Testliner, including brown testliner, brown kraft top liner, uncoated white top testliner, coated white top testliner, and mottled testliner
- Semi chemical fluting
- Recycled fluting and light-weight recycled medium.

These materials are used to manufacture corrugated board, which is then converted into corrugated packaging solutions (corrugated boxes) and other corrugated board products such as point of display stands. This study also covers the conversion of corrugated base papers into corrugated board and corrugated boxes.

The base weight of corrugated base papers can vary significantly but for liner it is typically in the range of 90-200gsm and for fluting it is typically in the range of 90-150gsm. The average base weight of corrugated base papers produced in the mills participating in this data survey was 135gsm.

The base weight of corrugated board depends on the specific corrugated base papers being used in the construction, plus the kind of flute (wave type) used. Different wave types lead to different heights of the corrugated layer and to different paper consumption (due to the take-up factor). In Table 2 indicative figures are given for different flute types, as an example.

Table 2 Flute types

Flute	Flute height* mm	Number of flutes per m length of the corrugated board	Take-up factor	Glue consumption g/ m ² glue layer
A	4.8	110	1.50-1.55	4.5-5.0
B	2.4	150	1.30-1.35	5.5-6.0
C	3.6	130	1.40-1.45	5.0-5.5
E	1.2	290	1.20-1.35	6.0-6.5
F,G,N	0.5-0.8	400-550	1.15-1.25	9.0-11.0

*facings excluded

The take-up factor governs the amount of fluting material required to manufacture the corrugated board. It allows for the fact that, when laid out flat before converting, the area of fluting material required to manufacture a defined area of corrugated board is greater than the surface of the converted board itself. For example, a typical take-up factor for C-flute is 1.43, meaning that 1.43m² of fluting (measured flat) is required to manufacture 1m² of converted corrugated board, as shown in the example in Figure 5.

Figure 2
Illustrating the take-up factor

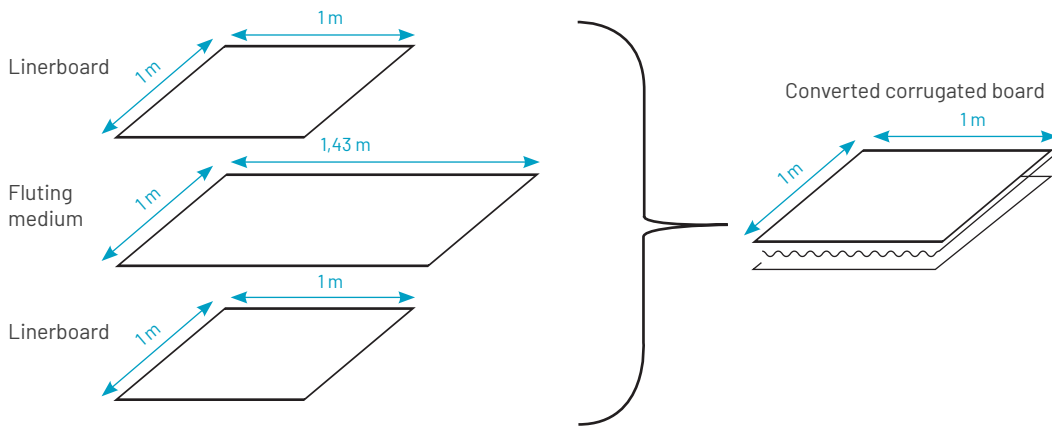

- Example: FEFCO Code 0201
- Box weight: 650 g
- Dimensions : 575 x 385 x 225 mm (L x B x H)
 corrugated board C flute
- Facings: Kraftliner 175 g/m², Testliner 175 g/m²
- Corrugating
- Medium: Recycled Fluting 140 g/m²

The composition of the corrugated board is then:

	g/m ²
Kraftliner	175
Recycled Fluting	1.43 x 140 = 200
Testliner	175
Glue	2 x 5 = 10
Grammage	560

Figure 5
Illustrating the take-up factor

The base weight of corrugated board can vary significantly, from less than 300gsm to more than 900gsm. The average grammage of corrugated board produced by manufacturers participating in this study was 515gsm, which is close to the average grammage of 506gsm across the industry⁶.

The corrugated board manufacturer can give the weight of the sheet before die-cutting. For a standard type construction the weight can also be calculated using the International Fibre Board Case Code published by FEFCO. In this code the form of the box blank is shown and by using the box dimensions it is possible to calculate the total length and width of the blank. Adding a 20 mm broad strip to the edges of the blank gives a fair estimate of the sheet area before die-cutting.

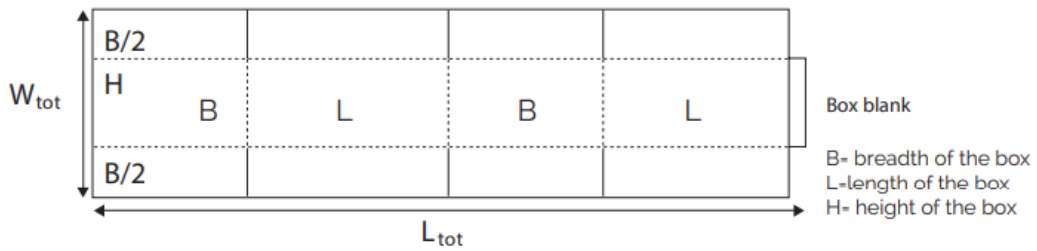

Figure 6
Box blank example

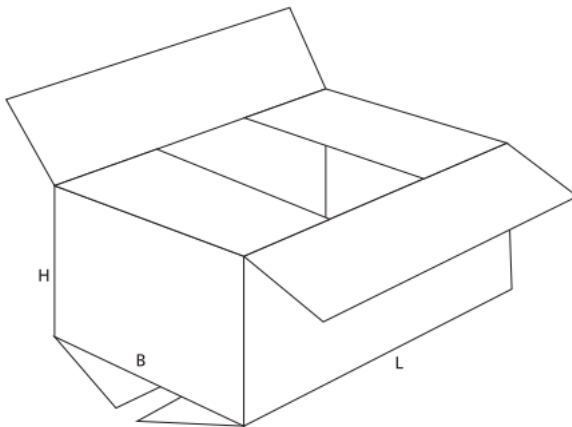

Figure 7
Converted box

Considering an example from Figure 6 where $L_{tot} = 1.95\text{m}$ and $W_{tot} = 0.61\text{m}$, the dimensions of the sheet are:

$$A_{\text{sheet}} = (1,95 + 0,04) \times (0,61 + 0,04) = 1,2935 \text{ m}^2$$

and the weight:

$$m_{\text{sheet}} = 1,2935 \times 560 = 724 \text{ g}$$

Assuming 3% as corrugator trimmings (i.e. $\eta_{\text{corrugator}} = 0.97$, a common value for modern corrugators), the consumption of liner and fluting can be calculated as follows:

		g/box
Kraftliner	$175 * 1.2935/0.97 =$	233
Recycled Fluting	$200 * 1.2935/0.97 =$	267
Testliner	$175 * 1.2935/0.97 =$	233
Glue	$10 * 1.2935/0.97 =$	13

746

Total (shavings) = $746 - 650 = 96 \text{ g/box} = 12.9\%$ of the input.

Please note that this is only an example of a particular box of a certain construction. Corrugated board boxes are far from standardised. They show a huge variation in composition, design and appearance. Boxes are usually tailor made to fit the user's needs and requirements which are determined by the product to be packed. The percentage of trimmings/shavings vary according to the design of the packaging. Since standard boxes do not exist, the database is set up in a flexible way giving the user the possibility to make calculations for any composition needed and using project specific assumptions on transport distance, waste management scenarios etc.



METHODOLOGY QUESTIONS

BOUNDARIES AND DECLARED UNIT

The gate-to-gate life cycle inventories for each grade of corrugated base papers are presented in the Annex according to the following declared unit:

***one air dry tonne (1000 kg) of net saleable paper at the parent reel,
before conversion to finished products***

The gate-to-gate inventory for conversion of corrugated base papers into corrugated board and boxes is presented in the Annex according to the following declared unit:

one tonne (1000 kg) of printed, slotted, folded and glued corrugated boxes

The compiled results presented in Table 4 of this report relate to the production ***one tonne (1000kg) of printed, slotted, folded and glued corrugated boxes***. The system boundaries considered for these results consider and quantify the flows to and from the technosphere and the environment from the papermill in-gate to corrugated box plant out-gate, as illustrated in Figure 8. In order to complete a cradle-to-gate analysis for corrugated boxes, life cycle data for the items shown in red must be added.

Figure 8
System boundaries for the results shown in Table 3

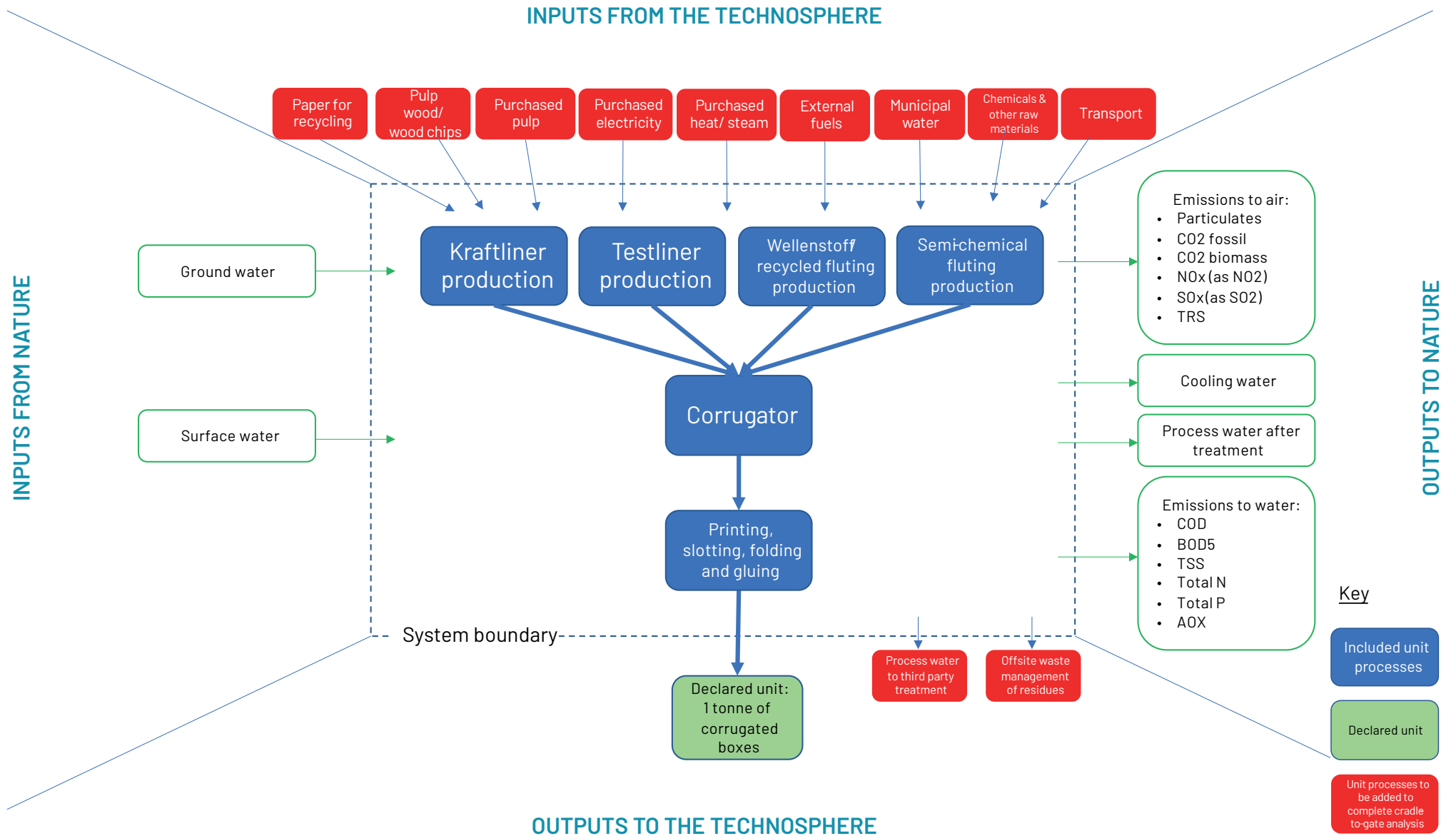



In addition to the compiled results shown in Table 4, separate data is presented in the Annex for production of the corrugated base paper grades (kraftliner, testliner recycled fluting and semi chemical fluting) and for the conversion of corrugated base papers into corrugated boxes (corrugating plus printing, slotting, folding and gluing). The system boundaries for these separate datasets are described below.

SYSTEM BOUNDARIES FOR CORRUGATED BASE PAPERS

The system boundaries of the life cycle inventories for corrugated base papers presented in the Annex include all activities within the pulp and papermill boundaries. Thus, included in the inventory are all the inputs and outputs (from/to the technosphere and from/to nature) associated with:

- Pulp production from pulp wood/wood chips
- Pulp production from paper for recycling
- Stock preparation, refining, and operation of the paper machine
- Drying
- Reeling and reel winding
- Supporting activities used in paper production, e.g. water and solid waste treatment, onsite electricity and heat/steam generation.

Figure 9 summarises the system boundaries. These system boundaries are representative of the core processes.

In cases where the mill produces and sells excess energy (e.g. electricity or steam), this is treated as a multifunctional situation. The system provides two functions (i.e. corrugated base paper plus energy). In this case, subdivision has been applied – i.e. only the inputs and outputs that are allocated to the paper production are reported in the life cycle inventory.

No allocation was made to by-products such as tall oil, turpentine and wood/bark chips, so the reported inputs and outputs include the production of these by-products.

For those paper mills producing more than one grade of paper and/or market pulp it is necessary to allocate inputs and outputs to the different paper grades or pulp. Mill staff who filled in the questionnaire have made the allocation according to causality.

Data has been collected relating to the following key non-fibre inputs to the pulp and papermaking processes:

- Sulphuric acid (H₂SO₄)
- Sodium hydroxide (NaOH)
- Oxygen (O₂)
- Hydrogen peroxide (H₂O₂)
- Sodium Chlorate (NaClO₃)
- Calcium oxide (CaO)
- Chlorine dioxide (ClO₂)
- Sodium bisulphite (NaHSO₃)
- Ground calcium carbonate (GCC)
- Precipitated calcium carbonate (PCC) – purchased
- Clay
- Wet strength agent
- Dry strength agent
- Synthetic binders (latex)
- Starch – maize
- Starch – potato
- Starch – corn/wheat
- Starch – cationic

The total mass of other non-fibre inputs not listed above is below 1% of the paper weight. As a general rule, these other non-fibre inputs could have been omitted from the study as insignificant. However, for completeness all non-fibre inputs for which data was reported by more than 6 mills have been included in the inventory.

Figure 9
Gate-to-gate system boundaries – production of corrugated base paper

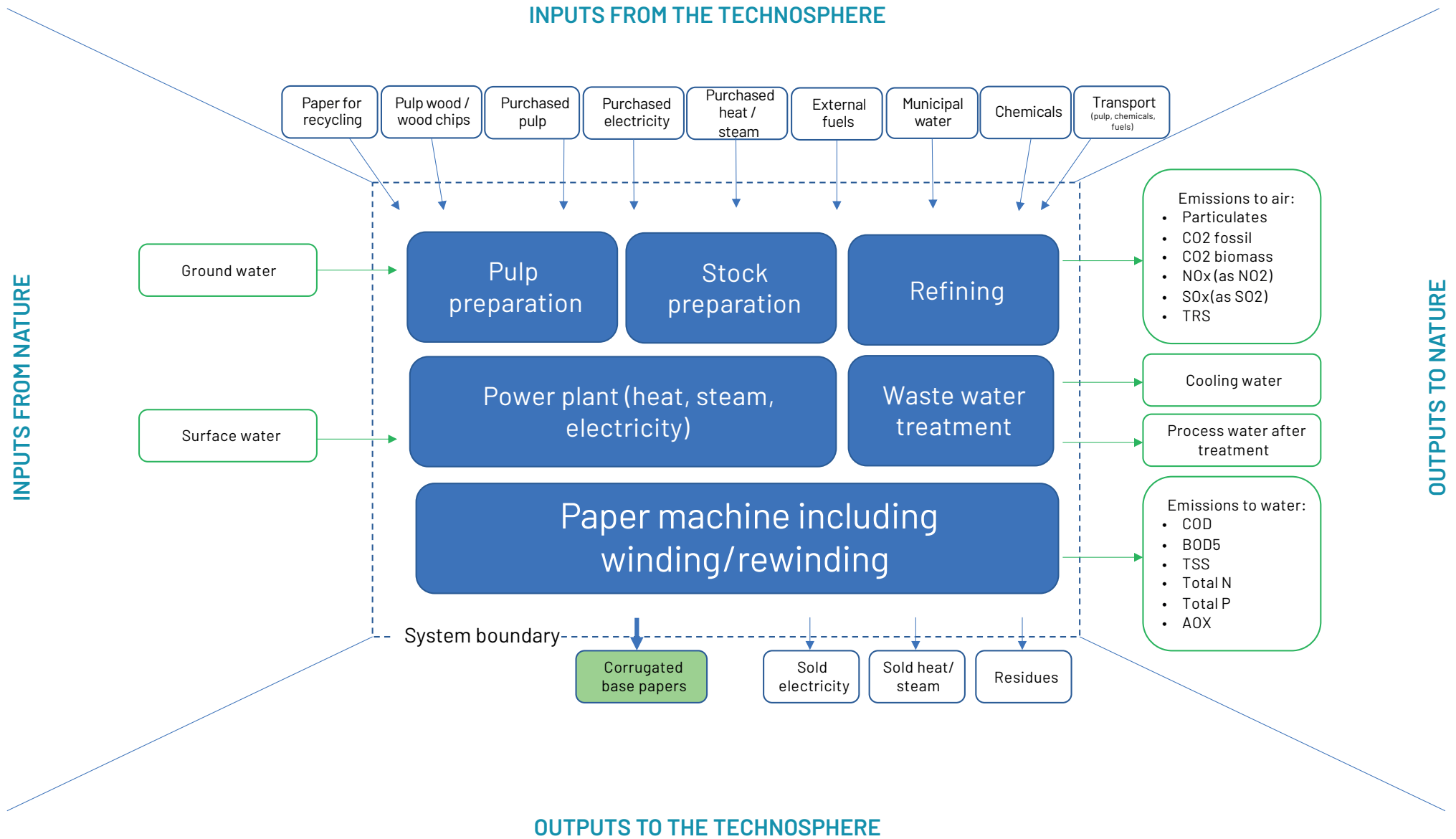



SYSTEM BOUNDARIES FOR CORRUGATED BOARD AND BOXES

The system boundaries of the life cycle inventory for conversion of corrugated base papers into corrugated board and boxes presented in the Annex include all activities associated with assembling corrugated base papers into corrugated board and converting corrugated board into corrugated boxes. Thus, included in the inventory are all the inputs and outputs (from/to the technosphere and from/to nature) associated with:

- The corrugator machine
- Printing
- Slotting
- Folding
- Gluing
- Supporting activities used in conversion process, e.g. onsite heat/steam generation, onsite wastewater treatment.

Figure 10 summarises the system boundaries.

Figure 10
Gate-to-gate system boundaries – production of corrugated board and corrugated boxes

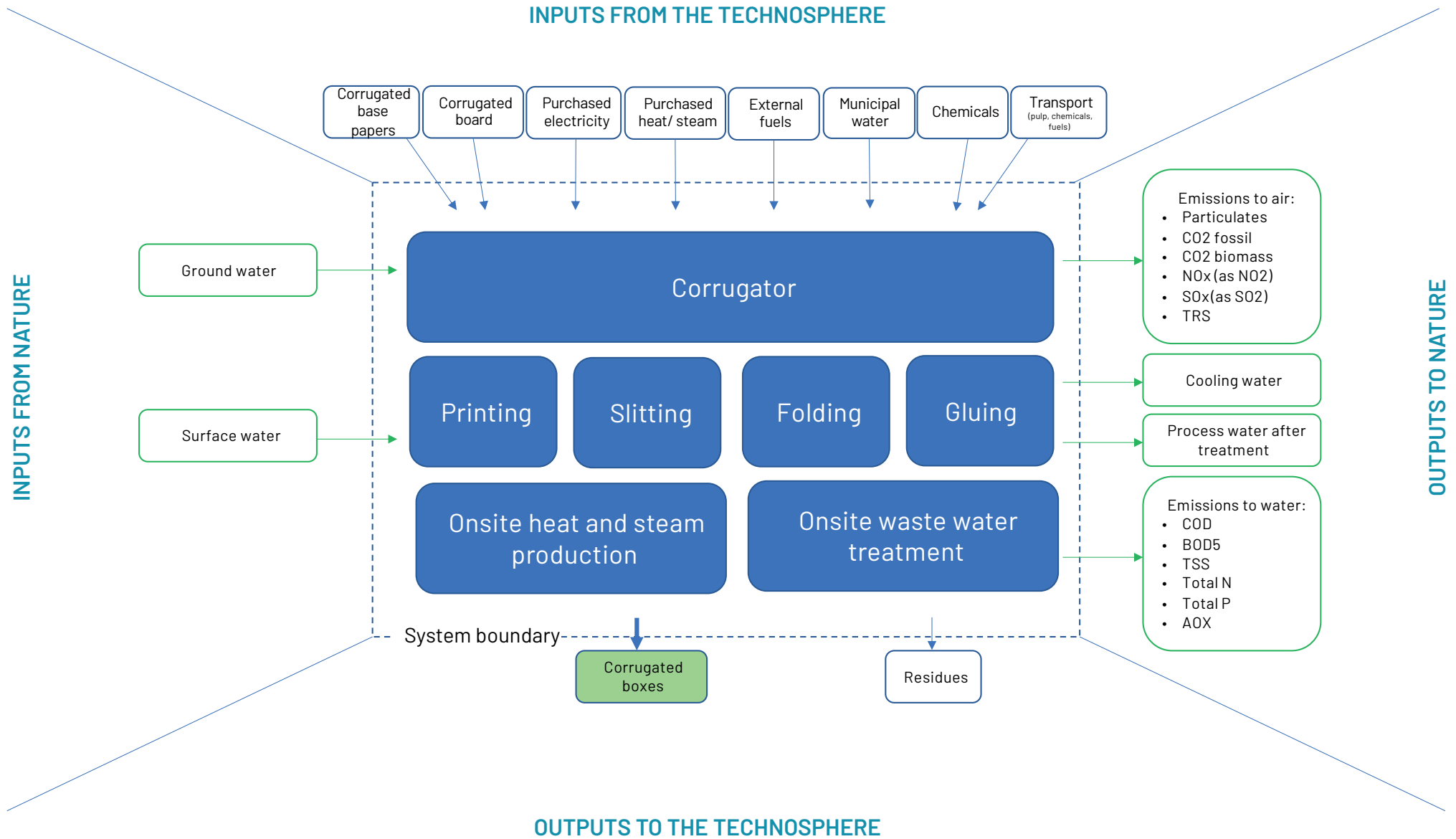



THE CLOSED-LOOP APPROACH

Many of the corrugated base paper grades considered in this life cycle database incorporate recovered fibres, and all of the paper grades achieve a high level of recycling after use, and the fibres themselves will be recycled multiple times.

This potentially introduces complexity to the analysis, as choices have to be made regarding the allocation of impacts between the primary fibre-based paper and the recovered fibre based paper, in particular:

- the impacts of the primary fibre pulp production and the final waste treatments
- the avoided impacts resulting from the recycling.

However, for the production of corrugated base papers a closed loop recycling situation is considered – i.e., the recovered material is assumed to be used in the same product life cycle. In this case, the collected fibres displace the input of primary fibres, and the need for allocation is avoided (as per ISO 14044).

Thus, to simplify the system, recycling of corrugated board may be considered as processing of the primary fibre after use in corrugated board or as raw material processing for the secondary product (or recycled products), also used in corrugated board. This is an appropriate and justifiable simplification as the main raw material for the recovered paper mills producing corrugated base papers is used corrugated board, thus flows in and out of the system of other kinds of paper are ignored.

The closed-loop approach requires that the total system is considered during a certain period of time and a specific geographic area. A simplified system for a closed-loop corrugated board packaging system is given in Figure 11.

There are different definitions for recycling and recovery (which could mean collection of waste or treatment of waste), depending on the application. This of course leads to the publication of different recycling/recovery rates.

For example, CEN 13440:2003 describes a procedure for calculating the rate of material recycling to demonstrate compliance with the recycling targets given in the Packaging and Packaging Waste Directive 94/62/EC (as amended by 2018/852/EC).

For the system described in Figure 11, fibres are recovered (in the sense of collected) from shavings from the production of corrugated board and from collected corrugated board after use, and following that are recycled in a papermaking process to become new paper.

Figure 11
Illustrating the closed-loop approach

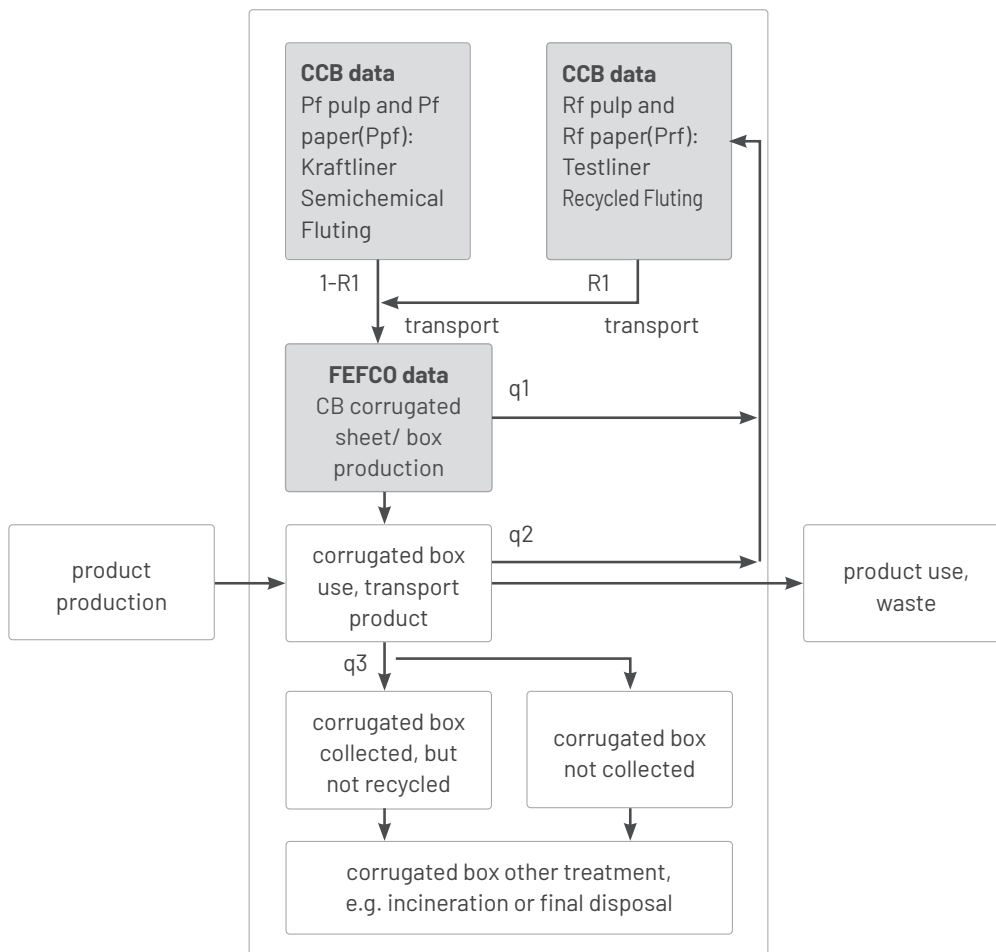

The recycled fibre content (R1) for this report is defined as total recovered fibre recycled from shavings ($q1$) as well as from used corrugated boxes ($q2$) divided by the total paper production used for corrugated board production.

- $q1$ is paper used for corrugated board production. Recycling is the common practice for collected (and if necessary sorted) corrugated board, but it may be that fibres are lost from the loop because not all corrugated packaging is collected. For corrugated board that is not recycled, other recovery options, such as incineration with energy recovery may take place. According to an estimation based on CEPI statistics for 2014, about 87% ($R2$) of the corrugated board used in Europe was collected and recycled.
- In a simplified system for closed-loop corrugated board packaging, this means that the percentage of recovered material is equal to $(R2 \times [1 - r_{sh}]) = 87\% \times [1 - 0.120] = 76.6\%$ of the input of the base papers would be recycled after use if all the recovered corrugated board was recycled only within the system. This is a simplification as a small part of the recovered fibre input originates from, for example, graphic paper loops and some collected corrugated board is recycled into other paper grades⁷.

For the purposes of this document, imports and exports of the corrugated board system are ignored, as are used packaging imports and exports. The application of this specific assumption means that the recycling rate of corrugated board (shavings + used packaging) is equal to the recovery rate of these products.

Table 2 shows that the average $R1$ for Europe in 2020 is about 88%. In this simplified approach this roughly

⁷ Based in the equation presented in Figure 11, the life cycle of the paper fibres in corrugated packaging is estimated to be fully circular at 87%. Within the context of the European recovered paper production environment, recovered fibres will typically be sent for use at the nearest appropriate recycled paper manufacturer. This may not necessarily be a packaging paper line. Some 60% of packaging is recovered at mills producing recycled paper for packaging, some 12% originate from other paper types such as recovered newsprint and the rest, 12% is clippings and trimmings from corrugating and conversion manufacturing.



corresponds with the total amount of collected shavings and used packaging as a percentage of the weight of the input of the base papers for the corrugated board production ($(q_1 + q_2)/\text{total paper production} \approx 90\%$), showing the validity of the closed-loop approach.

Note r_{sh} is not included in the calculation of the recycling rate according to the Directive on Packaging and Packaging Waste 94/62/EC and R2 does not include organic recycling as defined for the same purpose. Therefore, the recycling rate differs from the rate calculated to assess compliance with the recycling targets according to the Directive.

Definitions and calculations of recovery and recycling

Definitions of recovery and recycling EN 13193

Definitions set for the Directive on packaging and packaging waste 94/96/EC, as amended by Directive 2018/852/EC.

Recycling: any recovery operation by which waste materials are reprocessed into products, materials or substances whether for the original or other purposes. It includes the reprocessing of organic material but does not include energy recovery and the reprocessing into materials that are to be used as fuels or for backfilling operations.

Material recovery: any recovery operation, other than energy recovery and the reprocessing into materials that are to be used as fuels or other means to generate energy. It includes, inter alia, preparing for re-use, recycling and backfilling.

Packaging waste: any packaging or packaging material covered by the definition of waste laid down in Article 3 of Directive 2008/98/EC, excluding production residues.

Calculation of recycling rate EN 13440: 2003

$$r_n = (\delta_1 + \delta_2)/(\alpha + \beta - \gamma)$$

r_n = recycling rate of used packaging

δ_1 = material for organic recycling

δ_2 = material for material recycling

α = quantity of packaging put on the market for one way use

β = quantity of reusable packaging put on the market and used for the first time

γ = that part of used packaging which is not available for recycling due to other secondary uses

CEPI Recycling rate calculation

Recycling rate = utilisation of paper for recycling + net trade of paper for recycling, compared to paper & board consumption.

In 2017, the European Paper recycling rate (for all grades and products) was 72.3% (CEPI key statistics 2017) in Europe (EU-27 countries + Norway and Switzerland), meaning that over 55 million tons of paper-based products have been collected for recycling.

Concerning the Paper & Board Packaging recycling rate in Europe, according to CEPI statistics 2017, it amounts to 82.1%.

DATA DESCRIPTION

QUESTIONNAIRE DATA COLLECTION FOR CORRUGATED BASE PAPERS

The data was collected via a bespoke questionnaire issued to the mills requesting information on the flows into and out of the integrated pulp and paper mill. The questionnaire was designed to cover the main inputs to and outputs from the pulp and papermaking processes, including the supporting ancillary processes such as energy production, wastewater treatment, etc. The questionnaires were reviewed by technical experts and the peer reviewer before issuing to the industry. The questionnaires were issued during 2021, and data was provided representative of production scenarios in 2020.

The data for semi chemical fluting and kraftliner represent about 84% of the total annual production of corrugated base papers from primary fibres in Europe. These paper grades are produced in large mills, located in Austria, Finland, France, Portugal, Poland, and Sweden. Their total production was 4,698,905 tonnes net saleable paper in 2020. The mills each have an annual production of semi chemical fluting or kraftliner of between 94,000 and 467,000 tonnes net saleable paper. The data for the production of testliner (including white top testliner) and recycled fluting were collected from mills, together producing about 71% (17,084,104 tonnes) of the total annual production of corrugated base papers from recovered paper in Europe (EU-27 countries plus Norway, Switzerland and UK). They were provided by paper mills in Austria, Belgium, Bulgaria, Czech Republic, Denmark, France, Germany, Hungary, Italy, the Netherlands, Poland, Romania, Serbia, Spain, Sweden and the United Kingdom. The mills each have an annual production of testliner and/or recycled fluting of between 70,000 and 1,250,000 tonnes net saleable paper. The data for the production of white top testliner are included in the average of testliner.

For all papers, data was collected covering the average market and technology situation for the calendar year 2020. The collected data was sense-checked by technical experts and compiled as a weighted average representing production of each paper grade in 2020.

DATA COLLECTION FOR CORRUGATED BOARD AND BOX PRODUCTION

In order to gather data relating to converting, a questionnaire was designed covering the main inputs to and outputs from corrugated board production and corrugated box production processes. The questionnaires were reviewed by technical experts and the peer reviewer before issuing to the industry.

The data on corrugated board production and production of corrugated boxes are based on 470 plants (out of a total of 646 plants across Europe⁸). These were mostly integrated plants with corrugated board and box production on the same site. The plants were located in Austria, Belgium, Bulgaria, Czech Republic, Denmark, Estonia, Finland, France, Germany, Greece, Hungary, Ireland, Italy, Latvia, Lithuania, the Netherlands, Norway, Poland, Portugal, Romania, Russia, Serbia, Slovakia, Spain, Sweden, Switzerland, Turkey and the United Kingdom. Together they produced 18,730,000 tonnes saleable product, which is approximately 73% of the total annual production of corrugated board products in Europe. The production sites have an average annual production of corrugated sheets and boxes of 35,660 tonnes, varying from 320 – 148,000 tonnes each.

WEIGHTED AVERAGES

The Annex presents the weighted averages of the inputs into and outputs from the sites (i.e., gate to gate) per tonne net saleable product for each paper grade and for corrugated board/boxes for 2020 from the participating paper mills and corrugated board and box making plants. It is important to understand that the figures do not represent a certain mill or plant with a certain technology. On the contrary the figures represent a “virtual mill” and a “virtual converting plant” utilising different technologies. The technology which is applied



in the participating paper mills and corrugated board plants is not the same.

For example: some mills use a combined heat power generation, some wastewater treatment is external, a large variety of additives is used. In some cases, this leads to a large variation of inputs and outputs between the mills. Furthermore, different inputs and outputs are strongly interrelated, so a mill can be high in one input compared to the others but low in another input, but a mill cannot be low or high for both. Therefore, no range of the data is given to prevent studies from being made using a false combination of highest and lowest data.

Due to confidentiality requirements by the mills, it is not possible to split input and output data per country. Similarly, a split in applied technologies is not possible.

In Table 4, the separate life cycle inventories for corrugated base papers and for corrugated board and box production are combined to compile the life cycle inventory for an average tonne of corrugated boxes, considering both the production of the corrugated base paper and the conversion of the corrugated base papers into corrugated board and conversion of the corrugated board into boxes. For this average corrugated box scenario, the following composition has been assumed:

- Krafliner 14.6%
- Testliner and other recycled liner 45.1%
- Semi chemical fluting 1.8%
- Recycled fluting 38.5%

These relative shares are calculated from the relative consumption that is found in Table 1. The relative shares are used to calculate the inputs and outputs for the weighted average corrugated base paper. The paper production inputs and outputs are then multiplied with the average input of paper (1.12 tonne/tonne corrugated board product) and added up to the inputs and outputs per tonne of corrugated board product as reported in the Annex. This total includes the production of the paper that is used to produce the corrugated board, including the 12.0% losses that are reported as “paper for recycling”. It has to be kept in mind that the industry averages for inputs of paper, glue and starch are used. As previously highlighted, corrugated board boxes are far from standardised and inputs of paper, glue and starch depend on the box design.

MATERIAL INPUTS

Raw Material

The wood input has been reported as bone dry solid wood under bark. The species are specified, although in the datasets they are reported only as softwood or hardwood. 92% of the pulp wood used for the production of corrugated base papers by the companies returning the survey was certified and third party verified as being sourced from sustainable managed forests and delivered through a certified chain-of-custody system (PEFC or similar). A pulp yield (oven dry pulp/oven dry wood) of 54-56% is normal for Kraftliner. A high pulp yield of 80-85% is normal for Semi Chemical Fluting. The input of recovered paper has been reported as total weight including moisture and other materials (sand, metal objects, plastics, wood etc.). In European countries the water content of recovered paper is generally assumed to be about 10%. The total input of recovered paper is given. The content of other materials in the recovered paper is about 5%. These materials are eliminated from the pulp as rejects during the pulping. It is estimated that about a third of these rejects are materials that were associated with the previous use of the paper (for example, staples, paper clips, tags, adhesive labels, unrecovered fibres, etc). The remaining two thirds is material that is not in any way associated with the previous use of the paper (for example, foreign items such as textiles, plastic packaging, glass, sand and grit, etc). The main raw material inputs for corrugated board production are different grades of paper. The liners are used for the surface layers of the corrugated board, fluting is used for the corrugated layers. There are endless possibilities for the composition of corrugated board. The amount of the different grades of paper and glue used as input for the corrugated board production varies accordingly. These inputs should be considered when the LCA of a certain box is studied. An example is given in Figure 6. This should be kept in mind when considering the averages for paper consumption and the additives for corrugated board production in Table 4.

Chemicals and other non-fibre inputs

Data were collected for chemicals and other non-fibre inputs which may be used either within the process



or as additives. Chemicals are given as dry weight. Some of the inputs have been reported grouped together according to their function in the mill. The functional additives, mainly starch, influence the properties of the paper, whilst process additives are used to guarantee that the process of paper production runs smoothly or to increase the production. Water treatment additives include additives used for all water treatment on the site, including the treatment of water for the power station, paper production and waste water treatment if this is done internally. The different mills use a large variety of process and water treatment chemicals. Those that are commonly used and are above the cut-off criterion per mill are reported in the database. A very limited quantity of other additives, e.g. synthetic polymers (polyethylenamine, polyacrylamide, polyvinylamine) are being used. The main input for corrugated packaging is starch glue, containing starch and small amounts (less than 0.5 kg/tonne nsp) of caustic soda, borax, and wet strength agent. Only a few plants laminate the board and/or add a protective coating. All reporting plants that print the board use the flexo printing technique. For box making cold glue and small amounts (< 0.1 kg/tonne nsp) of hot melt, tape (paper or plastic), plastic tear strip and stitch wire are used.

Packaging

Data on cores and other packaging materials associated with paper reels and for packaging materials used around corrugated products was not collected and updated for 2021. Looking at previous data collections, the values showed little change over the years and other LCA studies show that the impacts of these packaging components are relatively small. Packaging for corrugated board products amounts to relatively small inputs of tape, wrappings of paper or plastic film, steel bands and pallets used as packaging of the saleable product. Pallets are also used in the logistic operations of the corrugated board industry. However, data on usage of pallets has not been collected. Previous iterations of the study have shown that the reported data on the use of pallets are confusing because of the complexity of the matter. Pallets can be returnable or one-way, only used internally in the plants and produced of wood, plastic or paper/ wood combinations. Previously some plants have reported their use in number of pallets while others have reported in kilogram pallet per tonne net saleable product, making it difficult to produce a meaningful figure.

Allocation to paper grades when a mill produces more than one paper grade

The basic data for raw material and chemical inputs are mainly based on recipes used for the production. When allocation was necessary, this was done according to mass production of the different papers.

MATERIAL OUTPUTS

The main output from the paper mills is of course paper. This includes about 2 kg of cores and plugs per tonne paper, which are considered and weighed as part of the net saleable product. The corrugated board plants produce corrugated board and boxes. The average moisture content of the saleable product is 9% for Semicheical Fluting and 8% for Kraftliner, 7.5% for Testliner and Wellenstoff, 7-8% for corrugated board. The main saleable by-products from the production of Kraftliner are tall oil and turpentine. These are included in the report.

Residues

All residues are reported as wet weight, separated according to their basic nature. Residues are only reported where they leave the system boundaries (i.e., where they are removed from and managed away from the site). As the mill is considered as a blackbox, energy and emissions associated with managing residues internally (onsite) are included within the gate-to-gate inventory data. The waste treatment was not reported by all mills. From the residues of the recycled paper mills, which are mainly rejects from the pulp preparation, it is estimated that about a third is due to rejected materials that were associated with the previous use of the paper (for example, staples, paper clips, tags, adhesive labels, unrecovered fibres, etc). The remaining two thirds is material that is not in anyway associated with the previous use of the paper (for example, foreign items such as textiles, plastic packaging, glass, sand and grit, etc). Primary sludge from wastewater treatment in mills producing Testliner and Recycled Fluting are mostly recycled in the process and do not leave the site. Ashes, green liquor sludge and lime mud are commonly reported residues from the production of primary fibre-based paper. They are usually landfilled, but lime mud is also used as fertilizer. For corrugated board the



main waste stream is paper for recycling, which is recycled and thus should not be called waste but recyclable material.

Allocation of residues to paper grades when a mill produces more than one paper grade

Data for material outputs are based on measurements. These have to be done because the mills have to pay for landfill and incineration or get paid for residues that are reused or recycled, like lubricants, according to the weight. When allocation was necessary, this was done according to mass of the different papers.

ENERGY INPUT AND OUTPUT

Fuel inputs to the sites have been reported in GJ. The lower calorific heat values have been used to calculate GJ from m³ or tonnes of fuel. Fossil fuel and biomass fuel have been reported separately. The energy figures for the sites include both energy for process and energy for infrastructure. No attempts have been made to differentiate between these two types of energy usage because process energy dominates (98% or more). Input of electricity into the sites is also reported. The electricity produced at the site itself is not reported. Some mills sell energy externally in the form of electricity, steam or warm water. The production sites are treated as a black box in the database, giving data on inputs and outputs only. Because no information is given about what happens within the box it is not possible to calculate an energy balance with the data in the database. Within this black box, energy is recovered through the burning of black liquor and bark from the wood coming in at production sites for primary fibre-based paper production. Most of the energy used in the process for Kraftliner production comes from internal burning of the black liquor. This inherent energy is not reported as part of the fuel input in the gate-to-gate inventory, although it is reported separately in Table 5. The total energy input for the process for Kraftliner production including the black liquor burning is around 14 GJ/tonne. The total energy input for the process of Semi Chemical Fluting production is around 10 GJ/tonne. The total energy input for the process of testliner and recycled fluting production is around 7 GJ/tonne. Combined heat power generation is applied at most of the production sites for recycled fibre based paper, but not always in the same way. The combined heat power generation can cover all or part of the steam consumption (Figure 12). When it covers only part of the steam consumption, then additional boilers also produce steam. The process always uses more heat (steam) than electricity. Therefore, when the installation is designed to cover the whole steam consumption more electricity is generated than is needed for the process. The excess of electricity is sold to the public grid. There are two possible ways of treating this excess electricity in an LCA.

- a. The production of electricity is an integral part of the paper production: it would not be produced if the paper were not produced. Paper is thus considered as the only “product” of the process. In an LCA this would mean that electricity generation for the public grid is “saved” when an excess of electricity produced at a paper mill is sold to the public grid. Thus environmental inputs and outputs are saved since combined heat power installation produces electricity with a higher efficiency than the public grid.
- b. Another possibility is to consider the paper and excess electricity as co-products. Paper and electricity are then both “products” from the process. In an LCA this would require allocation of inputs and outputs to both products.

The reported weighted averages of the fuel consumption and emission to air associated with the paper production are calculated according to method b, as this has become common practice at the mills. This means that the fuel consumption and emissions to air do not include the production of the sold electricity and the amount of the sold electricity is not reported. This was calculated as follows: the fuel consumption and emissions to air associated with the total heat production and the net electricity used on site were allocated to the paper production

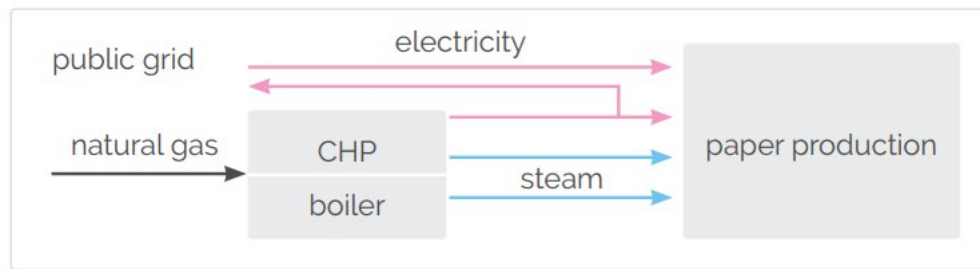

Figure 12
CHP, Combined heat and power generation

Diesel or gasoil/LPG used for internal transports are reported. Most of the energy consumed by the mills producing Kraftliner are by-products from the process and thus originates from the trees i.e. have biomass origin.

Allocation of energy to paper grades when a mill produces more than one paper grade

The energy is measured, because it is paid for. Allocation for fuels and electricity input is calculated according to energy (heat and electricity) required for the production of the different paper grades. Allocation of the other fuels, such as diesel oil used for internal transportation, was calculated according to mass production of each paper grade.

WATER INPUTS AND OUTPUTS

When paper mills use water, they do not consume this water during the production process. After (re)use it is returned to the rivers, lakes or seas as cooling water and purified effluent water. A limited amount of water is evaporated (about 1-1.5 m³/tonne nsp) in the drying section of the paper production. The water debate focuses on the impact of water consumption. This is best reflected in the local water availability rather than in the amount of water taken into the mills. Therefore, the appropriate indicator is the net difference of water taken in and water returned to the rivers or lakes (water consumed, not taken in).

TRANSPORT

The transport distances of wood raw materials from the harvesting sites in the forests to the mills have been reported separately for trucks, rail and ships. The trucks and rail wagons are normally loaded to full capacity but go back empty. The trucks carry 40-44 tonnes of wood. This information has been collected on a species-species basis for each mill, considering the wet weight of the wood. Data has also been collected for the delivery of saw mill residues and similar sources of fibre. Distances and tonnages of wood delivered have then been used to calculate the total t.km for delivery of wood by each mode of transport (truck, rail and boat). This is then used to calculate the t.km/t of production for each grade (Kraftliner, Semi Chemical Fluting and Recycled Fluting and Testliner) at each mill, calculated on a mill-by-mill, input-by-input basis. A weighted average t.km is then calculated based on the relative production share of each mill. A similar approach is applied for calculating the transport requirements for recovered paper. Transport distances from point of origin of the recovered paper bales to the mills have been reported on a recovered paper grade-by-grade basis for each mill. Distances and tonnages of recovered paper delivered have then been used to calculate the total t.km for delivery of recovered paper by each mode of transport (truck, rail and boat). This is then used to calculate the t.km/t of production for each grade (Kraftliner, Semi Chemical Fluting and Recycled Fluting and Testliner) at each mill, calculated on a mill-by-mill, input-by-input basis. A weighted average t.km is then based on the relative production share of each mill. Generally, the lorries are loaded to full capacity. On the return trip it is estimated that 40% of the trucks return empty. Assuming this is transported by a truck with a loading capacity of 40 tonnes this means that this figure has to be used in combination with data on inputs and outputs for transport by a 40t truck. Transport of the residues was not included in the questionnaire as this was seen to be part of the residue treatment. During the discussions with the technical experts it became

clear that the transport of rejects is mainly to nearby landfill, 3–30 km. Data was also collected from the papermills on average delivery distances and modes of transports to their customers. This data was provided on a product-by-product basis and was used to calculate a weighted average t.km for delivery of paper to the corrugated board plants. However, any one corrugating plant will of course source the substrates they use from many different suppliers. Therefore, the values presented in the inventory are only indicative and in practice users of the data may wish to consider delivery of materials on a case-by-case.

Internal transport is included in the energy input.

EMISSIONS TO AIR

Emissions from fuel combustion (transport, electricity generation for the public grid) outside the mill are not included in the data. In case the site sold electricity, the emissions associated with the sold electricity are not included. Emissions to air from the sites have been reported. For dust, TRS (H₂S), NO_x and SO_x the figures from the paper mills are mostly based on measurements. For CO₂ the figures reported are based on emissions reported to authorities where provided, or where these were not provided they are based on calculations and reported separately for fossil and biomass origin. Corrugated board plants have no measured air emission data to report. Therefore, the air emission figures for corrugated board production reported in Table 4 and in the Annex are calculated from reported figures for consumption of different fuels in the corrugated board plants. The emission factors in Table 3 were used for the calculations for fossil fuels. For biofuels, the following factors were applied: black liquor 110 kgCO₂e per GJ; wood, bark and wood chips 125 kgCO₂e per GJ; biogas 55 kgCO₂e per GJ. These emission factors were based on data provided by the mills.

Table 3 Default factors for calculating emissions to air from fossil fuels

	unit	natural gas	oil heavy	oil light/diesel	coal
CO ₂ (fossil) ¹	kg/GJ	56	78	74	95
CO*	g/GJ	2.1	7	4	100
Particulates, < 2.5 µm ²	g/GJ	0.2	35	0.1	20
Particulates, > 2.5 µm, and < 10µm ²	g/GJ		5		20
Particulates, > 10 µm ²	g/GJ		10		10
NO _x (as NO ₂) ²	g/GJ	18	100	50	200
SO _x (as SO ₂) ²	g/GJ	0.55	400	47	500
ecoinvent dataset name and ID-number		natural gas, burned in industrial furnace >100kW, RER, [MJ] (#1363)	heavy fuel oil, burned in industrial furnace 1MW, non-modulating, RER, [MJ] (#1589)	light fuel oil, burned in industrial furnace 1MW, non-modulating, RER, [MJ] (#1601)	Hard coal, burned in industrial furnace 1-10MW, RER [MJ] (#848)

¹ Source Intergovernmental Panel on Climate Change (extracted from Emission Factors Database, IPCC Guidelines version 2006)

² ecoinvent Centre, ecoinvent data v2.2 Sachbilanzen von Energiesystemen. Final report No. 6 ecoinvent data v2.0, 2007, Swiss Centre for Life Cycle Inventories, PSI, Duebendorf, CH, www.ecoinvent.org, 2012

Emissions to air in the flue gas from the CHP the power station are given for the mills producing testliner and recycled fluting that use combined heat power generation. Emissions from the incineration of rejects with energy recovery at the mill are included. Emissions in the steam from the drying section of the paper machines are not included. When mills have anaerobic wastewater treatment on the site, biogas originating



from this process is used as a fuel by the mill. The emissions to air originating from the use of biogas as fuel are included.

Very few mills were able to report any figures for emissions such as metals etc. Where data was reported the same substances were not always covered and where common emissions were reported these showed a large variation per mill, primarily due to differences in measuring/monitoring and/or calculation regimes. Therefore, this information has not been included in the datasets. For conducting their own LCI or LCA studies, users of the dataset are advised that they should include such emissions. These can be estimated through the application of standard emissions data for the combustion of different fossil fuels, together with the amount of fossil fuels used in the processes (as indicated in Table 4 and the Annex). This will allow an estimation to be made of the order of magnitude of these emissions.

Allocation of emissions to paper grades when a mill produces more than one paper grade

Emissions to air are calculated from measurements, applied technology, permit values or from the input of fuels. Necessary allocations were done in the same way as for energy input.

EMISSIONS TO WATER

Water that is taken in must be treated before it is used in the process, and it is again treated after the process before it is released as effluent to a recipient. The substances in the effluent after wastewater treatment are reported. All mills have some sort of effluent water treatment, either mechanical treatment by sedimentation or in addition biological anaerobic and aerobic or chemical treatment of the effluent. A few mills send their effluent water to an external communal treatment plant. The volume of effluent water is reported separately for treated process water and thermally polluted effluent (e.g. cooling water). All mills have reported the figures for outgoing effluent water to the recipient i.e. effluent water after final treatment. The amount of substances (COD, BOD, suspended solids) per m³ of effluent from the different mills show very little variation when the efficiency of the waste water treatment station is the same. The amount of substances per tonne paper production may however vary according to the amount of effluent, depending on specific circumstances in the paper production process in the different mills. In the questionnaire for data collection, a number of other emissions were asked for such as oils, nitrates, acids, AOX, chlorate, chlorides, borates, phenol, Hg, Pb etc. Few mills were able to report figures, probably because there are no or few measurements. Only COD, BOD5, suspended solids, total nitrogen and total phosphorus are based on data from most mills in addition to the total volume of effluent waters. Due to the water treatment it is possible that the content of certain substances per m³ is higher if the water is taken from a river than in the effluent released into the river. In an LCA this would mean that the production of paper could be credited for the reduction in substances, although in practice this rarely happens. This principle is illustrated in Figure 13.

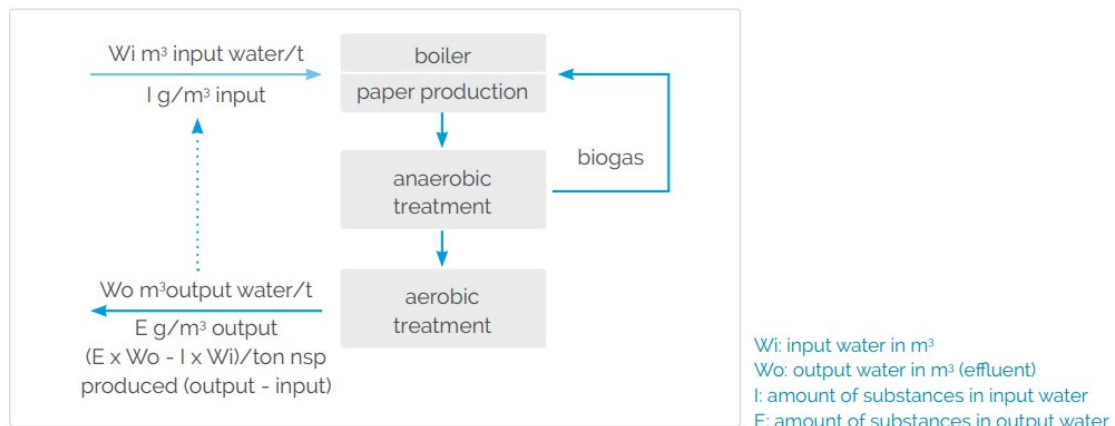

Figure 13
Potential credit for reduction of substances in the effluent water



Since only a few mills analyse their incoming water the available data cannot be considered as representative. Therefore, only data for the emissions to the recipient are given, without taking into account the substances in the incoming water. Most of the corrugated board plants have internal wastewater treatment that can be treated externally afterwards. In case the wastewater is not further treated externally and released to the environment, the emission level of substances is so low that reporting them is not required by authorities. The reported data are therefore based on a small sample. Besides the substances reported in Table 4 and the Annex, very few plants have also given data on some of the following emissions: metals (Cadmium, Chromium, Lead, Nickel, Iron, Boron, Aluminium), AOX, Chlorine and Phosphorus. The amounts are below 0.001 kg/tonne nsp.

Allocation of emissions to paper grades when a mill produces more than one paper grade

As far as waterborne emissions per m³ are measured for a mill, these data are well documented. The figures reported are usually based on continuous measurements according to control programmes set by official authorities. Given emissions to water are measured according to standard methodology. Where necessary, allocation between paper grades is done according to mass of produced paper grade. The water used for the production of White Top Testliner is relatively higher than for Brown Testliner and Recycled Fluting. No separate data are reported as the effluent from its production is mixed with that from the production of other grades produced on site. Data on emissions to water from the corrugated plants were also collected. However, the corrugated plants are not subject to Industrial Emissions legislation, and therefore the quantity and quality of available data is inconsistent. This is further complicated by the fact that the corrugated plants do not all have their own effluent treatment facilities or treat only certain aspects of the wastewater associated with specific processes (for example, ink recovery). Many plants discharge a proportion of their wastewater under specific agreement to public effluent treatment facilities and therefore do not have access to data on the releases to the environment (after final treatment). It did not prove possible to make a reliable analysis with the data collected during the latest survey. For this reason, data representative of emissions after a public waste water treatment plant should be considered for the waste emissions from the corrugated plant.

DATA

COVERAGE AND COMPARABILITY OF THE DATASETS

CCB and FEFCO have regularly surveyed the environmental performance of the corrugated industry for more than 25 years. This is the tenth edition of the report. Inevitably, over time the coverage of the surveys has changed:

- Old paper mills and converting facilities have closed and new mills and converting facilities have opened
- Additional mills and converting facilities have opted to participate in the survey, increasing the coverage and representativeness of the datasets

In particular, for the 2020 survey there was a significant increase in the number of mills and converting facilities which contributed data to the surveys:

- 59 mills producing corrugated base papers contributed to the 2020 survey compared to 50 mills participating in the 2017 survey, representing an 18% increase in participation
- 470 converting plants contributed to the 2020 survey compared to 389 converting plants participating in the 2017 survey, representing a 21% increase in participation

This increased participation in the survey means that the weighted averages generated are more representative of average European production, and therefore represents an improvement in the quality of the datasets. However, it also means that comparing the weighted averages across the surveys is meaningless, with trends obscured by changes in participation in the surveys. The weighted average results presented in this edition of the report should therefore not be compared directly with the weighted average results in the previous editions of the report.

Therefore, in order to investigate trends, a comparison has also been made on a like-for-like basis, considering only those mills which also contributed data to the 2017 survey.

PRODUCTION TRENDS UNIQUE TO 2020

The data was collected in 2021, representative of the production environment in 2020.

It is worth noting that in some mills and converting plants production parameters during 2020 were affected by the external influence of the COVID-19 pandemic. In particular, some respondents to the questionnaires reported the following deviations from standard production processes:

- For some mills co-producing energy as a product, external demand for electricity was reduced and therefore there was less sold electricity. As a result, a greater share of purchased fuels and emissions to air are allocated to paper production compared to previous years
- During the pandemic, demand was higher than usual for standard brown boxes. Production of these is more efficient as there is less board waste. This may in part account for the lower board wastage rates at the corrugated converting plants observed in the current survey compared to the 2017 survey.

In addition, it was observed that:

- Corrugated base paper base weights (measured in grams per square metre) have been reduced during this period – and therefore, whilst energy consumption per square meter may have reduced, energy consumption per tonne of production may have increased
- There is a continued drive to improve recycled fibre quality and an increase in sizing and coated papers, which may have contributed to an increase in energy consumption per tonne of production.

It is not possible to ascertain if these trends have influenced the results of the life cycle inventory, but this qualitative information provides some context to some of the results achieved and trends observed.



RELATIONSHIP TO THE PRODUCT ENVIRONMENTAL FOOTPRINT (PEF)

CCB and FEFCO have been compiling the environmental database for the European corrugated industry for more than twenty-five years. Over the course of multiple iterations of the project a robust process has been developed in which the data provided is processed and checked by both LCA practitioners and industry experts. The process and data are then subjected to an independent peer review.

This experience has led to the generation of a well-respected and transparent life cycle inventory dataset for the production of corrugated base papers and the conversion of these base papers into corrugated board and corrugated boxes. Therefore, CCB and FEFCO intend to continue to collect and process the data using the same methods and present the information in the same format.

More recently, the European Commission has proposed the Product Environmental Footprint (PEF) as a common way of measuring environmental performance⁹. To facilitate the adoption of the PEF methodology, the European Commission is developing a database of life cycle inventory data. Category rules for compiling life cycle studies in compliance with the PEF methodology are also in development. PEF category rules have already been published for Intermediate Paper Products¹⁰, but no category rules have been published covering the conversion of these into end products.

The PEF methodology and the PEF database are still in development and open to discussion, and category rules are currently only available for the production of base papers not including conversion. Therefore, whilst the data for this life cycle inventory has been collected with reference to the PEF and, where relevant, the Product Category rules for Intermediate Paper Products, no claim of compliance with the PEF methodology or data requirements is made.

⁹ <https://eplca.jrc.ec.europa.eu/EnvironmentalFootprint.html?msclid=d1c44024bd6311ec9a31602979545205>

¹⁰ Product Environmental Footprint Category Rules: Intermediate Paper Products, CEPI, October 2018

RESULTS

LIFE CYCLE INVENTORY FOR CORRUGATED BOARD 2020

Table 4 shows the calculated inputs and outputs for the production of 1 tonne of corrugated board products in Europe with an average corrugated base paper composition. The production of corrugated board is normally expressed in m². However, for LCA it is preferable to have it expressed in weight.

For the average corrugated board product, the paper input is 1.12 tonnes/tonne corrugated board, with an output of 0.12 tonnes paper for recycling.

The original five datasets for the four main paper grades and corrugated board/box production from which the data are derived, are reported in the Annex. The data for the corrugated box is calculated by multiplying the average paper grade composition by 1.12 and adding the corrugated board/box data reported in the Annex.

Table 4

Life cycle inventory for the production of 1 tonne of corrugated boxes in Europe, with average corrugated base paper composition

PRODUCT		2021
	tonne net saleable product	1
SOLD BYPRODUCTS		
Tall oil	kg/t	3.39
Turpentine	kg/t	0.19
RAW MATERIAL		
Wood consumption	as bone dry weight (= 45% of transported total wet weight)	
Softwood logs	t/t	0.10
Hardwood logs	t/t	0.04
Sawmill residues softwood	t/t	0.03
Sawmill residue hardwood	t/t	0.00
<i>Total wood</i>	<i>t/t</i>	<i>0.18</i>
Recovered paper	as wet weight	1.04
Category		
Mixed grades	t/t	0.49
Corrugated and Kraft, pre-consumer	t/t	0.09
Corrugated and Kraft, post-consumer	t/t	0.44
Newspaper and Magazines	t/t	0.01
Other grades	t/t	0.02
Purchased pulp consumption	as bone dry weight	
Bleached pulp	t/t	0.0072
Unbleached pulp	t/t	0.0062
Paper consumption for corrugated board production		
Total	t/t	1.12



TRANSPORT OF RAW MATERIALS		
Wood		
Wood with truck	t.km/t	181
Wood with rail	t.km/t	18
Wood with boat	t.km/t	50
Recovered paper		
Recovered paper with truck	t.km/t	456
Recovered paper with rail	t.km/t	23
Recovered paper with boat	t.km/t	22
Paper to corrugated board plants*		
Paper with truck	t.km/t	553
Paper with rail	t.km/t	614
Paper with boat	t.km/t	320
ENERGY INPUTS		
Steam		
Bought electricity	GJ/t	1.376
Fossil fuels		
Natural gas	GJ/t	4.720
Heavy fuel oil	GJ/t	0.037
Light fuel oil	GJ/t	0.031
Diesel oil	GJ/t	0.005
LPG	GJ/t	0.015
Coal	GJ/t	0.331
Lignite	GJ/t	0.149
Peat	GJ/t	0.045
<i>Total fossil fuels</i>	<i>GJ/t</i>	<i>5.333</i>
Renewable fuels		
Biofuel (bark, scrap wood, tall oil)	GJ/t	0.662
<i>Total renewable fuels</i>	<i>GJ/t</i>	<i>0.662</i>
Refuse derived fuel		
<i>Total fuel</i>	<i>GJ/t</i>	<i>6.129</i>
WATER		
Input total		
Ground water (non-renewable)	m ³ /t	0.41
Ground water (renewable)	m ³ /t	2.65
Surface water	m ³ /t	10.20
Municipal water	m ³ /t	0.69
Rainwater	m ³ /t	0.08
Other water received	m ³ /t	0.00
<i>Water in - water out</i>	<i>m³/t</i>	<i>1.64</i>



PROCESS CHEMICALS AND ADDITIVES, DRY MASS		
Alum (Al ₂ (SO ₄) ₃)	kg/t	0.26
Biocides	kg/t	0.49
Borax	kg/t	0.24
CaCO ₃	kg/t	5.17
CaO	kg/t	0.84
Colourants	kg/t	0.30
CO ₂	kg/t	0.29
Defoamer	kg/t	0.15
Fillers	kg/t	3.24
Glue, cold and hot melts	kg/t	1.10
H ₂ O ₂ , peroxide	kg/t	0.44
H ₂ SO ₄	kg/t	1.06
Water-based ink for flexo printing	kg/t	0.93
Varnish for printing	kg/t	0.53
Ligno sulphonate	kg/t	0.76
Lubricants	kg/t	0.06
MgO	kg/t	0.03
NaClO ₃	kg/t	0.04
Na ₂ CO ₃ (soda)	kg/t	0.29
Na ₂ SO ₄	kg/t	0.11
NaOH	kg/t	2.67
NH ₃	kg/t	0.02
Oxygen, O ₂	kg/t	0.29
PAC (polyaluminiumchlorid)	kg/t	0.30
Pitch dispergents	kg/t	0.02
Polymer and retention agents	kg/t	1.30
S, sulphur	kg/t	0.10
Sizing agents	kg/t	0.61
SO ₂	kg/t	0.00
Starch, corn	kg/t	22.31
Starch, potato	kg/t	0.00
Starch, wheat	kg/t	28.17
Starch, modified	kg/t	5.15

EMISSIONS TO AIR		
Particulates, <2.5µm	kg/t	0.0076
Particulates, >2.5µm and <10µm	kg/t	0.0041
Particulates, >10µm	kg/t	0.0202
CO ₂ (fossil)	kg/t	346.17
CO ₂ (biomass)	kg/t	256.88
CO	kg/t	0.31
NO _x (as NO ₂)	kg/t	0.68
SO _x (as SO ₂)	kg/t	0.13
TRS (H ₂ S as S)	kg/t	0.001
EMISSIONS TO WATER		
Water output	m ³ /t	
Thermally polluted water	m ³ /t	8.15
Process water after treatment	m ³ /t	3.79
<i>Total water out</i>	m ³ /t	11.94
Waterborne emissions		
COD	kg/t	3.08
BOD ₅	kg/t	0.36
TOC	kg/t	0.19
Suspended solids	kg/t	0.67
Total Nitrogen	kg/t	0.12
AOX	kg/t	0.02
Total Phosphorous	kg/t	0.01
RESIDUES		wet weight
Calcium carbonate	kg/t (75% dry content)	2.22
Ink residues	kg/t (50% dry content)	2.00
Inorganic ashes (10 01 01)	kg/t (85% dry content)	13.10
Inorganic sludges	kg/t (32% dry content)	1.43
Organic sludges (03 03 01 and 03 03 11)	kg/t (43% dry content)	135.35
Paper for recycling	kg/t (90% dry content)	121.49
Rejects, paper related**	kg/t (57% dry content)	15.47
Rejects, other***	kg/t (57% dry content)	30.93
Starch, glue (wet weight)	kg/t (30% dry content)	0.25
Lubricants and oil	Kg/t	0.10

«0» no input or below reporting requirements see «chemical input»

«na» not available

*As this life cycle inventory is intended to be representative of average European production, only transport from European paper mills to European corrugated board production sites has been considered in the weighted average. Transport associated with export of paper outside of Europe has not been considered

**Rejected materials that were associated with the previous use of the paper (for example, staples, paper clips, tags, adhesive labels, unrecovered fibres, etc)

***Material that is not in any way associated with the previous use of the paper (for example, foreign items such as plastic packaging, glass, sand and grit, etc)

ADDITIONAL INFORMATION ON ENERGY AND FUELS

INTERNAL FUELS

The energy inputs presented in Table 4 and in the life cycle inventories detailed in the Annex refers only to external fuels supplied to the process. However, many papermills also produce their own internal fuels as a by-product of the pulping processes or from the management of waste streams. In particular, the following are the main internal fuels relevant to the papermaking process:

- Black liquor – a by-product from the kraft process when digesting pulpwood into paper pulp. It is an aqueous solution of lignin residues, hemicellulose, and the inorganic chemicals used in the process
- Bark – from the debarking process
- Biogas and biosludge – from the wastewater treatment process
- Refuse-derived fuel – from the processed rejects from processing of paper for recycling

The consumption of all fuels and energy (purchased fuels and electricity and internal fuels) for each of the corrugated paper grades is summarised in Table 5. This data is for information purposes only and should not be added to the life cycle inventory for each paper grade as it refers to fuels that are generated and consumed within the “black box” of the papermill. The internal fuels will be used for production of heat (in the form of steam) and electricity at the mill.

Table 5
External energy inputs and internal fuels consumed for the production of corrugated base papers

		Semi chemical fluting production	Kraftliner production	Recycled fluting production	Testliner production
EXTERNAL ENERGY INPUTS					
Steam	GJ/t	0.000	0.366	0.508	0.508
Bought electricity	GJ/t	0.920	1.088	0.785	0.785
External fuels	GJ/t	3.683	2.965	5.036	5.036
<i>Total external energy inputs</i>	<i>GJ/t</i>	<i>4.603</i>	<i>4.419</i>	<i>6.329</i>	<i>6.329</i>
INTERNAL FUELS					
Black liquor	GJ/t	3.964	8.203	0.000	0.000
Bark	GJ/t	1.707	1.372	0.000	0.000
Biogas and biosludge	GJ/t	0.069	0.087	0.266	0.266
Refuse derived fuel (RDF)	GJ/t	0.000	0.024	0.299	0.299
Other internal fuels	GJ/t	0.116	0.114	0.035	0.035
<i>Total internal fuels</i>	<i>GJ/t</i>	<i>5.856</i>	<i>9.800</i>	<i>0.600</i>	<i>0.600</i>
TOTAL ENERGY (BOUGHT ELECTRICITY, PURCHASED STEAM, EXTERNAL FUELS, INTERNAL FUELS)					
Total energy	GJ/t	10.459	14.219	6.929	6.929

YEAR-ON-YEAR TRENDS

The life cycle inventory presented in Table 4 represents the average European production of corrugated board products with an average corrugated base paper composition, based on the data received during from mills and plants participating in the 2020 survey. As previously explained, the coverage of the 2020 survey is significantly increased for the 2020 survey compared to the 2017 survey. Whilst this means that the life cycle inventory presented in this version of the report is more representative of the weighted European average production, it also means that it is not valid to compare this current inventory with previous versions of the dataset.

Changes in the coverage of the papermills participating in the survey are particularly influential on the results achieved.

Therefore, in order to investigate trends, a comparison has also been made on a like-for-like basis, considering only those mills which also contributed data to the 2017 survey. Key findings from this like-for-like comparison are:

- Total wood consumption per tonne of corrugated board product is reduced by 18% from 0.22 tonnes per tonne to 0.18 tonnes per tonne.
- Total recovered paper consumption per tonne of corrugated board product is reduced by 4% from 1.09 tonnes per tonne to 1.05 tonnes per tonne.
- Purchased electricity is increased by 7% from 1.24 GJ per tonne to 1.33 GJ per tonne, but consumption of external fuels has decreased by 3% from 6.18 GJ per tonne to 6.00 GJ per tonne. In particular, consumption of fossil fuels has decreased by 5% from 5.43 GJ per tonne to 5.14 GJ per tonne.
- Subsequently, fossil CO₂ emissions have been reduced by 2% from 342 kg per tonne to 336 kg per tonne. Emissions of CO₂ from biogenic sources have also been reduced by 12% from 294 kg per tonne to 258 kg per tonne.
- Other emissions to air have also been reduced. For example:
 - NO_x emissions have been reduced by 28% from 0.58 kg per tonne to 0.42 kg per tonne.
 - SO_x emissions have been reduced by 33% from 0.15 kg per tonne to 0.10 kg per tonne.
- Total water input is reduced by 6% from 13.55 m³ per tonne to 12.79 m³ per tonne.

SUSTAINABLE FOREST MANAGEMENT

There is currently no life cycle impact assessment methodology for biodiversity impacts of forest management to produce primary fibres for fibre-based products. Nevertheless, biodiversity impacts are an essential element of forest industry products. Sustainable forest management practices have been developed to protect and maintain the ecosystem services in managed forests and plantations. The voluntary sustainable forest management certification schemes have been designed to address relevant practices that help protect ecosystem services such as biodiversity or those that are impacted by land use and their implementation has been verified through an accredited, independent third party. These practices set a proxy for mitigating land use impacts and protecting biodiversity.

The data collection revealed that 92% of the pulp wood used for the production of corrugated base papers by the companies returning the survey was certified as being sourced from sustainable managed forests. Predominantly, primary fibres are FSC or PEFC certified.

Details of the specific countries of origin and species of wood used are not provided in this report. The data provided by incomplete and when reviewed it was not deemed representative of the complete situation.



PEER REVIEW

The study presented in this report has been subject to a peer review by ifeu - Institute for Energy and Environmental Research Heidelberg GmbH. The peer review concludes that:

- the methods used to compile the database are scientifically and technically valid, and consistently used.
- the data used are appropriate and reasonable in relation to the goal of the LCA database.
- the LCA database report is transparent and consistent.

The full peer review statement is available as Annex 2 of this report.

DEFINITIONS

ALLOCATION

Technique used in life cycle assessment for partitioning the inputs and outputs of a system amongst products.

CONVERTED CORRUGATED BOX

The corrugated board that is ready to use as a box. All shavings are accounted for.

EFFLUENT

Water leaving the mill after treatment.

INCINERATION + ENERGY

Incineration of residues with energy recovery.

FLUTING

Paper grades used for the corrugated layer of corrugated board.

FUNCTIONAL ADDITIVES

Additives that influence the properties of paper.

LINER

Paper grades used for the surface layer of corrugated board.

LIFE CYCLE ASSESSMENT (LCA)

Compilation and evaluation of the inputs, outputs and the potential environmental impacts of a product system throughout its life cycle.

LIFE CYCLE IMPACT ASSESSMENT

Phase of the life cycle assessment aimed at understanding and evaluating the magnitude and significance of the potential environmental impacts of a product system.

LIFE CYCLE INVENTORY ANALYSIS

Phase of the life cycle assessment involving compilation, and the quantification of inputs and outputs, for a given product system throughout its life cycle.

PACKAGING MATERIALS

Materials bought and used for the packaging of the saleable product (wrappings, pallets).

PAPER FOR RECYCLING

paper collected for repulping at a papermill to produce papers containing recycled fibres. Paper for recycling may originate from pre-consumer sources (e.g., process waste) or post-consumer sources

PRIMARY FIBRE

Virgin fibre, fibres that have not been recycled before use in paper production.

PROCESS ADDITIVES

Additives that are used to guarantee that the process of paper production runs smoothly or to increase the production.

REJECTS

Material in recovered paper, which is eliminated during pulp preparation.

SHAVINGS

The total of all base paper cuttings that do not end up in the converted corrugated box (e.g. from corrugator trimmings, die-cuttings). Shavings are 100% recycled.

TONNE NSP (NET SALEABLE PRODUCT)

1 tonne of paper/corrugated board product sold to the customer, including core plugs for the paper.

TRANSPORT DISTANCE OF RECOVERED PAPER

Distance from recovered paper supplier to the paper mill.

TRANSPORT DISTANCE OF WOOD

Distance from harvesting site to the paper mill.

RECYCLED FLUTING

Recovered fibre-based Fluting

RECOVERED FIBRES

fibres produced from recycled paper ready for use in paper production

ANNEX 1

GATE-TO-GATE INVENTORIES FOR CORRUGATED BASE PAPERS AND CORRUGATED CONVERTING PROCESSES

PRODUCT	tonne net saleable product	Semi chemical fluting production	Kraftliner production	Recycled fluting production	Testliner production	Corrugated board production
SOLD BYPRODUCTS						
Tall oil	kg/t	14.91	18.88	0.00	0.00	0.00
Turpentine	kg/t	1.51	0.97	0.00	0.00	0.00
RAW MATERIAL						
Wood consumption	as bone dry weight (= 45% of transported total wet weight)					
Softwood logs	t/t	0.00	0.63	0.00	0.00	0.00
Hardwood logs	t/t	0.80	0.14	0.00	0.00	0.00
Sawmill residues softwood	t/t	0.00	0.20	0.00	0.00	0.00
Sawmill residue hardwood	t/t	0.06	0.00	0.00	0.00	0.00
<i>Total wood</i>	<i>t/t</i>	<i>0.85</i>	<i>0.97</i>	<i>0.00</i>	<i>0.00</i>	<i>0.00</i>
Recovered paper	as wet weight	0.1527	0.2782	1.0632	1.0632	0.0000
Category						
Mixed grades	t/t	0.0184	0.1141	0.5065	0.5065	0.0000
Corrugated and Kraft, pre-consumer	t/t	0.0318	0.0258	0.0903	0.0903	0.0000
Corrugated and Kraft, post-consumer	t/t	0.0833	0.1373	0.4407	0.4407	0.0000
Newspaper and Magazines	t/t	0.0000	0.0000	0.0082	0.0082	0.0000
Other grades	t/t	0.0193	0.0010	0.0175	0.0175	0.0000
Purchased pulp consumption	as bone dry weight					
Bleached pulp	t/t	0.0000	0.0422	0.0003	0.0003	0.0000
Unbleached pulp	t/t	0.0000	0.0378	0.0000	0.0000	0.0000
Paper consumption for corrugated board production						
Total	t/t	0.0000	0.0000	0.0000	0.0000	1.120
TRANSPORT OF RAW MATERIALS						
Wood						
Wood with truck	t.km/t	512	737	0	0	0



Wood with rail	t.km/t	88	101	0	0	0
Wood with boat	t.km/t	89	297	0	0	0
Recovered paper						
Recovered paper with truck	t.km/t	104	118	464	464	0
Recovered paper with rail	t.km/t	0	143	0	0	0
Recovered paper with boat	t.km/t	0	51	14	14	0
Paper to corrugated board plants*						
Paper with truck	t.km/t	0	0	0	0	553
Paper with rail	t.km/t	0	0	0	0	614
Paper with boat	t.km/t	0	0	0	0	320
ENERGY INPUTS						
Steam	GJ/t	0.000	0.366	0.508	0.508	0.032
Bought electricity	GJ/t	0.920	1.088	0.785	0.785	0.444
Fossil fuels						
Natural gas	GJ/t	0.000	0.887	4.028	4.028	0.803
Heavy fuel oil	GJ/t	0.187	0.133	0.002	0.002	0.010
Light fuel oil	GJ/t	0.010	0.055	0.014	0.014	0.009
Diesel oil	GJ/t	0.002	0.001	0.005	0.005	0.001
LPG	GJ/t	0.000	0.023	0.001	0.001	0.011
Coal	GJ/t	0.025	0.037	0.333	0.333	0.013
Lignite	GJ/t	0.000	0.000	0.159	0.159	0.000
Peat	GJ/t	2.184	0.006	0.000	0.000	0.000
<i>Total fossil fuels</i>	<i>GJ/t</i>	<i>2.408</i>	<i>1.142</i>	<i>4.541</i>	<i>4.541</i>	<i>0.847</i>
Renewable fuels						
Biofuel (bark, scrap wood, tall oil)	GJ/t	1.275	1.823	0.352	0.352	0.008
<i>Total renewable fuels</i>	<i>GJ/t</i>	<i>1.275</i>	<i>1.823</i>	<i>0.352</i>	<i>0.352</i>	<i>0.008</i>
Refuse derived fuel	GJ/t	0.000	0.000	0.144	0.144	0.000
<i>Total fuel</i>	<i>GJ/t</i>	<i>3.683</i>	<i>2.965</i>	<i>5.036</i>	<i>5.036</i>	<i>0.855</i>
WATER						
Input total	m ³ /t	41.97	31.65	7.68	7.68	0.40
Ground water (non-renewable)	m ³ /t	0.00	0.00	0.42	0.42	0.01
Ground water (renewable)	m ³ /t	0.00	0.14	2.71	2.71	0.09
Surface water	m ³ /t	41.97	31.19	4.53	4.53	0.01
Municipal water	m ³ /t	0.00	0.06	0.44	0.44	0.28
Rainwater	m ³ /t	0.00	0.32	0.03	0.03	0.00
Other water received	m ³ /t	0.00	0.00	0.00	0.00	0.00
<i>Water in - water out</i>	<i>m³/t</i>	<i>0.84</i>	<i>1.29</i>	<i>1.30</i>	<i>1.30</i>	<i>0.19</i>
PROCESS CHEMICALS AND ADDITIVES, DRY MASS						
Alum (Al ₂ (SO ₄) ₃)	kg/t	0.00	1.54	0.009	0.009	0.00
Biocides	kg/t	0.09	0.23	0.48	0.48	0.00
Borax	kg/t	0.00	0.00	0.00	0.00	0.24
CaCO ₃	kg/t	0.00	14.23	3.03	3.03	0.00
CaO	kg/t	0.00	4.29	0.15	0.15	0.00



Colourants	kg/t	0.00	0.01	0.32	0.32	0.00
CO ₂	kg/t	0.00	1.77	0.00	0.00	0.00
Defoamer	kg/t	0.03	0.17	0.13	0.13	0.00
Fillers	kg/t	0.00	12.48	1.28	1.28	0.00
Glue, cold and hot melts	kg/t	0.00	0.00	0.00	0.00	1.10
H ₂ O ₂ , peroxide	kg/t	0.00	2.68	0.00	0.00	0.00
H ₂ SO ₄	kg/t	0.06	6.10	0.07	0.07	0.00
Water-based ink for flexo printing	kg/t	0.00	0.00	0.00	0.00	0.93
Varnish for printing	kg/t	0.00	0.00	0.00	0.00	0.53
Ligno sulphonate	kg/t	0.00	0.00	0.81	0.81	0.00
Lubricants	kg/t	0.00	0.069	0.050	0.050	0.00
MgO	kg/t	1.47	0.00	0.00	0.00	0.00
NaClO ₃	kg/t	0.000	0.000	0.040	0.040	0.000
Na ₂ CO ₃ (soda)	kg/t	14.13	0.00	0.00	0.00	0.00
Na ₂ SO ₄	kg/t	0.00	0.68	0.00	0.00	0.00
NaOH	kg/t	4.36	6.72	0.34	0.34	1.17
NH ₃	kg/t	0.015	0.037	0.010	0.010	0.000
Oxygen, O ₂	kg/t	0.00	1.78	0.00	0.00	0.00
PAC (polyaluminiumchlorid)	kg/t	0.00	1.09	0.13	0.13	0.00
Pitch dispergents	kg/t	0.00	0.00	0.025	0.025	0.00
Polymer and retention agents	kg/t	0.58	1.88	1.05	1.05	0.00
S, sulphur	kg/t	4.72	0.00	0.00	0.00	0.00
Sizing agents	kg/t	0.062	0.689	0.526	0.526	0.000
SO ₂	kg/t	0.00	0.00	0.00	0.00	0.00
Starch, corn	kg/t	0.00	0.00	17.37	17.37	6.04
Starch, potato	kg/t	0.00	0.00	0.00	0.00	0.00
Starch, wheat	kg/t	0.00	3.31	28.27	28.27	1.16
Starch, modified	kg/t	0.00	5.02	0.40	0.40	3.95

EMISSIONS TO AIR

Particulates, <2.5µm	kg/t	0.0233	0.0268	0.0021	0.0021	0.00077
Particulates, >2.5µm and <10µm	kg/t	0.0129	0.0149	0.0011	0.0011	0.00030
Particulates, >10µm	kg/t	0.0687	0.0790	0.0061	0.0061	0.00023
CO ₂ (fossil)	kg/t	252.51	80.31	299.39	299.39	47.62
CO ₂ (biomass)	kg/t	746.39	1176.98	51.32	51.32	1.33
CO	kg/t	0.74	1.40	0.067	0.067	0.00
NOx (as NO ₂)	kg/t	1.02	0.83	0.54	0.54	0.018
SOx (as SO ₂)	kg/t	0.52	0.17	0.081	0.081	0.011
TRS (H ₂ S as S)	kg/t	0.0395	0.0035	0.000	0.000	0.000

EMISSIONS TO WATER

Water output	m ³ /t					
Thermally polluted water	m ³ /t	17.06	15.21	5.68	5.68	0.00036



Process water after treatment	m ³ /t	24.07	15.15	0.69	0.69	0.18
Total water out	m ³ /t	41.13	30.36	6.37	6.37	0.18
Waterborne emissions						
COD	kg/t	5.59	4.06	2.12	2.12	0.31
BOD5	kg/t	0.20	1.04	0.20	0.20	na
TOC	kg/t	0.00	1.06	0.014	0.014	na
Suspended solids	kg/t	0.41	0.77	0.49	0.49	0.074
Total Nitrogen	kg/t	0.44	0.084	0.10	0.10	0.0061
AOX	kg/t	0.000	0.0017	0.0258	0.0258	na
Total Phosphorous	kg/t	0.0078	0.0127	0.0093	0.0093	0.0012
RESIDUES	wet weight					
Calcium carbonate	kg/t (75% dry content)	0.0030	13.6	0.00	0.00	0.00
Ink residues	kg/t (50% dry content)	0.00	0.00	0.00	0.00	2.00
Inorganic ashes (10 01 01)	kg/t (85% dry content)	20.1	12.9	11.3	11.3	0.0
Inorganic sludges	kg/t (32% dry content)	0.40	8.70	0.00	0.00	0.00
Organic sludges (03 03 01 and 03 03 11)	kg/t (43% dry content)	44.6	10.2	141.3	141.3	0.44
Paper for recycling	kg/t (90% dry content)	0	0	0	0	121
Rejects, paper related**	kg/t (57% dry content)	3.0	3.7	15.8	15.8	0.0
Rejects, other***	kg/t (57% dry content)	6.0	7.5	31.6	31.6	0.00
Starch, glue (wet weight)	kg/t (30% dry content)	0.00	0.00	0.00	0.00	0.25
Lubricants and oil	Kg/t	0.133	0.130	0.040	0.040	0.043

«0» no input or below reporting requirements see «chemical input»

«na» not available

*As this life cycle inventory is intended to be representative of average European production, only transport from European paper mills to European corrugated board production sites has been considered in the weighted average. Transport associated with export of paper outside of Europe has not been considered

**Rejected materials that were associated with the previous use of the paper (for example, staples, paper clips, tags, adhesive labels, unrecovered fibres, etc)

***Material that is not in anyway associated with the previous use of the paper (for example, foreign items such as plastic packaging, glass, sand and grit, etc)

ANNEX 2



INSTITUT FÜR ENERGIE-
UND UMWELTFORSCHUNG
HEIDELBERG

Review statement on European database for corrugated board life cycle studies, 2021

Dataset owners: CEPI Containerboard & FEFCO corrugated packaging

Dataset developer: Michael Sturges, RISE - Research Institutes of Sweden

Reviewer: Frank Wellenreuther, ifeu - Institut for Energy and Environmental
Research

Heidelberg, June 2022



Index

1 Background and Goal	3
2 Review procedure	4
2.1 Documents provided and reviewed	4
3 Conclusion	8

1 Background and Goal

CEPI ContainerBoard (CCB) and the European Federation of Corrugated Board Manufacturers (FEFCO) collected data from the industry to document the environmental impact of corrugated board.

The result is a European database for life cycle studies that includes data for the production of:

- Corrugated base papers from primary fibres: Kraftliner, White Top Kraftliner and Semicheical Fluting (data from CCB)
- Corrugated base papers from recovered papers: Testliner, White Top Testliner and Wellenstoff (data from CCB)
- Corrugated board products (data from FEFCO).

The data is the tenth edition of the database and represents averages of the inputs and outputs from the production sites per tonne paper and per tonne of corrugated board product for the year 2020.

The database report has been prepared bei RISE Bioeconomy.

The updated database was presented to Frank Wellenreuther of ifeu gGmbH for critical review.

The goal of the review presented here is to ensure that:

- the methods used to compile the database are scientifically and technically valid,
- the methods are used consistently within the FEFCO LCA database,
- the data used are appropriate and reasonable in relation to the goal of the LCA Database
- the LCA database report is transparent and consistent

2 Review procedure

This review has been commissioned by FEFCO on the 04th of December 2020. The review work has been conducted in two steps. For the first step, on the 11th of December 2020, the dataset developer provided the data collection questionnaires for review before sending them out to the data providers. In the second step the final draft database report including an annex with gate-to-gate inventory data for corrugated base papers and corrugated converting processes was provided for review on the 25th of April 2022. An updated database report was sent on the 16th of June 2022.

This review statement has been sent to the commissioner and the dataset developer on the 24th of June 2022. It refers to the latest version of the database report received on the 16th of June 2022.

2.1 Documents provided and reviewed

The dataset developer provided the reviewer with several documents relevant for a clear understanding of the data compilation process. Those documents were as follows:

Data collection questionnaires

- Papermills questionnaire – draft final 10-12-2020.xlsx
- Draft questionnaire – corrugated sheets and boxes.xlsx

The draft data collection questionnaires were made accessible to the reviewer on the 11th of December 2020.

After receiving and considering comments from the critical reviewer the final revised versions of these data questionnaires as used for the actual data collection were then also shared on the 05th of January 2021:

- Papermills questionnaire – final 05-01-2021.xlsx
- corrugated sheets and boxes questionnaire – final 05-01-2021.xlsx

- The questionnaires follow a top-down approach to data collection consistently.
- Information about all annual inputs and outputs was requested.
- As no allocation was made for by-products the inputs and outputs include the production of these by-products
- The participation of mills and converting facilities have increased compared to earlier versions of this dataset, therefore the representativeness has been further improved.

⇒ The questionnaires are considered to be well-suited to their purpose to collect all relevant gate-to-gate data.

Database report

- FEFCO environmental database – draft final report 25-04-2022-marked-up.docx
- FEFCO environmental database - draft final report 16-06-2022-changes highlighted.docx

This final draft of the database report has been sent to the reviewer on the 16th of June 2022.

- The report contains a single European average inventory dataset covering corrugated board production including the production of the four main paper grades used.
- In an annex to the report the separate gate-to-gate inventory datasets for the four paper grades and the converting process are also included.
- It contains a very detailed section describing the production processes.
- The dataset for the corrugated board is calculated by multiplying the average paper grade composition data from the paper mills with 1.12 (as on average 1.12 tonne of paper is used for 1 tonne corrugated board) and adding the corrugated board data from converting facilities.
 - ⇒ The detailed section describing production processes is well written and very much appreciated as it will help non-professionals to understand and therefore use this dataset correctly.
 - ⇒ This calculation approach is transparently presented in the report and considered suitable for the generating of one average dataset.
- The underlying datasets differ in their representativeness. The data for Semi-chemical Fluting and Kraftliner represent more than 84% of the total annual production of corrugated base papers from primary fibres in Europe. The data for the production of Testliners and Wellenstoff represent about 71% of the total annual production of corrugated base papers from recovered paper in Europe. The data on corrugated board production represents 73% the total annual production of corrugated board in Europe.
 - ⇒ The resulting dataset is considered to be representative of the European production of corrugated board and the reference year 2020. The overall representativity could be improved compared to the previous version (#9) of this database.
- Allocation of inputs and outputs was not necessary in all cases of data collection. At some sites only one grade of product is produced, at some the mills were able to assign inputs of raw materials to the different products. In remaining cases allocation between co-products has been done by data providers according to causality.
- Inputs and outputs allocated to other products (not by-products) and sold energy have been excluded from the inventory data.
- No allocation was made to by-products, so the reported inventory includes the production of these by-products.

- ⇒ The allocation procedure is considered suitable to deliver the most valid results possible.

Inventory data

Unlike the previous version of this database report, the inventory data is not presented in a separated excel file but directly included into the report. An annex also presents the separate gate-to-gate datasets for the production of the main paper grades and the converting process.

- The inventory tables include the inputs and outputs per ton net saleable product.
- The list of material inputs does not include packaging material.
- The list of material outputs includes residues.
- Total sums for some material or energy inputs are additionally presented.
- Apart from material and energy flows also transport parameters for wood, recovered paper and also paper to corrugating plants are listed.
- An additional table listing internal fuels, which are not added to the inventory data as their emissions are already accounted for, is presented.

- ⇒ Biogenic and fossil based CO₂ is reported transparently
- ⇒ The reviewer appreciates the consideration of peat as fossil fuel regarding the quality of CO₂ emissions.
- ⇒ Packaging materials are not included although they have been collected via the data questionnaires and were included in the 2018 version of this database.
- ⇒ Water balances have been checked by the reviewer and are found to be sufficiently closed (the difference is also reported in the inventory)
- ⇒ The inclusion of internal fuels for information purposes only is appreciated

3 Conclusion

The presented documentation of the dataset is considered transparent and correct, clearly describing how the dataset has been built up and what it represents in terms of production, technology, geography and time. This is considered appropriate for the intended application: gate-to-gate LCI dataset for production of corrugated board for use in LCI/LCA studies.

- ⇒ the methods used to compile the database are scientifically and technically valid,
- ⇒ and consistently used within the FEFCO LCA database,
- ⇒ the data used are appropriate and reasonable in relation to the goal of the LCA database
- ⇒ the LCA database report is transparent and consistent

The input and output flows have been cross-checked by the reviewer with other paper sector datasets and have been found to have a high level of completeness including all relevant flows of inputs of raw materials and energy.

Limitations

The data set refers to European industry average. This review does not apply to any individual datasets collected at single mills or corrugated board plants.

Heidelberg, 24.06.2022



Frank Wellenreuther, ifeu gGmbH



The Federation of Corrugated Board Manufacturers

Avenue Louise 250

B - 1050 Brussels

Tel + 32 2 646 40 70

www.fefco.org

Twitter: @FEFCO

General information and requests for publications:

info@fefco.org

Printed on recycled paper